



FLOOR GRINDERS  
INDUSTRIAL VACUUMS  
DIAMOND TOOLS

*Equipments and products  
for any kind of floor*

# KS 240 GRINDING MACHINE



MADE in ITALY

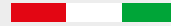

**Folding handle** for easy transport and facilitated storage



**REMOVABLE LATERAL INLET**

to perform the working flush with the wall.



**INTEGRATED DUST COLLECTION** with rear suction.

Extraction pipe connection with tube supports.

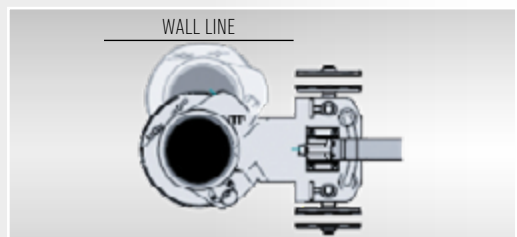

**SWIVELLING FRAME**

the lateral inlet allow to use the machine as EDGER MACHINE.

**KS 240** is a single-disc grinder designed for the preparation of small and medium surfaces. KS 240 is very easy to use because it reduces drastically the vibrations to the operator, thanks to the vacuum connection is possible to work without dust.

KS 240 is the perfect machine for the preparation of at surfaces, floor levelling, the preparation of the concrete before painting, removing of coating defects or adhesives, mastic, paints, resins. Repairing of damaged concrete and grinding rough surfaces.



**GAC2542 € 85,00 cad.**  
Diamond insert for standard concrete

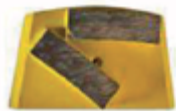

**GAC2546 € 85,00 cad.**  
Diamond insert for ceramic, glue residue and very hard concrete

**KS 240 ESTIMATED PRODUCTION\* - Sqm/H**

Concrete grinding <b>1 Step</b>	20 - 25
Terrazzo grinding <b>5 Step</b>	45 - 47
Glue removal <b>1 Step</b>	15 - 25
Paint removal <b>1 Step</b>	10 - 20

\*production numbers may vary according to the surface conditions, diamonds used, equipment operator, etc.

**TECHNICAL DATA**

Power	2,2 Kw - 3 Hp	Tooling system	5 diamond insert
Working Width	240 mm	Tool holder	240mm / 9,5"
Voltage	220 V - 50 Hz	Application	Dry
Weight	55Kg	Dust-vacuum	Yes
Amperage	Max 12 Amp	Speed	1450 rpm
		<b>Price</b>	<b>€ 2.490,00</b>

# GRINDEX 350



**QUICK CHANGE TOOLING SYSTEM**



**SWIVELING FRAME SYSTEM**



**WALL LINE**



**96KG**  
Heavy grinding machine



**Adjustable handle**



**Lateral inlet**

**Integrate dust collecting system**

**Powerful 3 kW  
4 HP motor**

**Available  
220 V or 380 V  
with soft start  
and variable speed**

**GRINDEX 350:** powerful single-disc grinder fitted with wide disc 350mm, designed for preparation of Concrete and Natural Stone surfaces. GRINDEX 350 is available in 3 versions: 220 V with variable speed, 380 V fixed speed, 380 V with variable speed. The swiveling frame system and the 2 lateral inlets allow to use the machine also as EDGER MACHINE.

96 Kilos total weight, easy to use, equipped with a special anti-shock system which drastically reduce the vibration to the operator. The integrate dust collecting system allows to work dust free. Quick disassembly of the head from the frame and fast electric disconnection for easy transport. Suitable for repairing and leveling damaged floors, grinding of rough surfaces, preparation of concrete surfaces before resin, removing of different kind of coatings like glue, resin and varnish and more.

Also suitable for bush-hammering, grinding, polishing and fast exposing of aggregates.

## GRINDEX 350 PRODUCTIVITY RATES - Sqm/H

Concrete grinding <b>1Step</b>	40 - 45
Terrazzo grinding <b>1Step</b>	60 - 85
Glue removal <b>1Step</b>	30 - 35
Paint removal <b>1Step</b>	20 - 35

## TECHNICAL DATA

Model	Power	Voltage - Frequency	Amperage	Working Width	Tool speed	Tool size	Water tank	Weight	PRICE
<b>GRINDEX 350 380 V</b>	3 kW - 4 HP	380-400 V 50-60 Hz	Max 14 Amp	350mm	700 rpm	Quick change	N/A	96 Kg	€ 2.990,00
<b>GRINDEX 350 VS 220 V</b>	3 kW - 4 HP	220 V 50-60 Hz	Max 14 Amp	350mm	0-700 rpm	Quick change	N/A	96 Kg	€ 3.450,00
<b>GRINDEX 350 VS 380 V</b>	3 kW - 4 HP	380-400 V 50-60 Hz	Max 14 Amp	350mm	0-700 rpm	Quick change	N/A	96 Kg	€ 3.590,00

# HG180 VS HAND GRINDER



180 mm

VARIABLE SPEED



**HG180 VS:** Hand grinder for corners, edges, countertops, skirtings, stairs and small surfaces. HG180 VS combines power and ease-of-use features for improved performance. It is engineered for smoothing and levelling concrete surface and concrete seams. The constant speed under load allows to complete heavy works. HG180 VS includes the protective Vacuum hood.

**MAIN FEATURES**

- Variable speed 3200 - 5600 rpm
- LED indicator overload/overheating
- Sliding cover with spring system
- Ergonomic adjustable handle with soft grip
- Powerful motor 2200W
- Anti accidental reboot system
- Vacuum hood with replaceable brush
- Constant speed under load

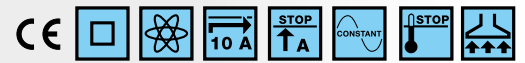

**EFFICIENT VACUUM HOOD**  
with replaceable brush and sliding cover



**VACUUM COVER WITH SPRING SYSTEM**



**LED LOAD INDICATOR**  
allows the operator to work at peak efficiency.



**MAIN TOOLS**

**EDGE MASTER 5-STEP GRINDING SYSTEM**

High performing ceramic bond to refine and blend your edge work faster and more efficiently for concrete floors. Wet and dry use.



Edge Master Ceramic Turbo Cup, M14	Ø 180mm - X Coarse	€ 155,00
Edge Master Ceramic Turbo Cup, M14	Ø 180mm - Coarse	€ 155,00
Edge Master Ceramic Turbo Cup, M14	Ø 180mm - Medium	€ 155,00
Edge Master Ceramic Turbo Cup, M14	Ø 180mm - Fine	€ 155,00
Edge Master Ceramic Turbo Cup, M14	Ø 180mm - X Fine	€ 155,00

**TECHNICAL DATA**

Power	2200 W (220V)	Tool diameter	180 mm
Variable speed	3200 - 5600 rpm	Weight	5 Kg
Hole	22,23 mm - 7/8"	Connection	M14
<b>Price</b>		<b>€ 1.610,00</b>	

# HG125 VS HAND GRINDER



**EFFICIENT VACUUM HOOD**  
with replaceable brush



**SLIDING COVER WITH SPRING SYSTEM**



**ERGONOMIC ADJUSTABLE HANDLE**

## MAIN FEATURES

- Variable speed 4300 - 7200 rpm
- Powerful motor 2200W
- LED indicator overload/overheating
- Vacuum hood with replaceable brush
- Sliding cover with spring system
- Constant speed under load
- Ergonomic adjustable handle with soft grip
- Anti accidental reboot system

VARIABLE  
SPEED



125 mm



LED indicator  
overload/overheating

Waterproof  
dustproof switch

Powerful motor  
2200W

**HG125 VS:** Variable Speed Hand grinder for corners, edges, countertops, skirtings, stairs and small surfaces and for opening the joints. HG125 VS is the ideal machine to achieve a perfect grinding of natural stones, concrete and a perfect polishing of countertops, shelves, tables and narrow areas. It can be used as a edge grinder, as well as a joint chaser thanks to its extra accessories.

HG125 VS includes protective Vacuum hood.

## MAIN TOOLS



### METAL BOND TURBO CUP

Designed for grinding stone and concrete surfaces.  
Offered in: Coarse, Medium and Fine grit.

Turbo Cup, M14 Ø 125mm - Coarse	€ 134,00
Turbo Cup, M14 Ø 125mm - Medium	€ 134,00
Turbo Cup, M14 Ø 125mm - Fine	€ 134,00



### EDGE MASTER 5-STEP GRIND SYSTEM

High performing ceramic bond for concrete floors. Wet and dry use.

Edge Master Ceramic, M14 Ø 125mm - X Coarse	€ 134,00
Edge Master Ceramic, M14 Ø 125mm - Coarse	€ 134,00
Edge Master Ceramic, M14 Ø 125mm - Medium	€ 134,00
Edge Master Ceramic, M14 Ø 125mm - Fine	€ 134,00
Edge Master Ceramic, M14 Ø 125mm - X Fine	€ 134,00

## TECHNICAL DATA

Power	2200 W (220V)	Tool diameter	125 mm
Variable speed	4300 - 7200 rpm	Weight	4,7 Kg
Hole	22,23 mm - 7/8"	Connection	M14
		<b>Price</b>	<b>€ 1.380,00</b>



# Speedy

## 3 STEP

NEW FASTER & LESS EXPENSIVE POLISHING SYSTEM  
CONCRETE - MARBLE - TERRAZZO

**STEP 1**



**STEP 2**

**STEP 3**

READY... SET...  
**GRIND!**



# SPEEDY 3 Step

## SUITABLE FOR CONCRETE, MARBLE AND TERRAZZO



**SPEEDY 3 STEP:** new faster and cheaper polishing system developed by Klinsystem. Suitable for Concrete, Marble and Terrazzo. NEW 3 STEP System allows drastic **reduction of grinding and polishing time and costs**. Large increase of productivity preserving **high quality standards**. SPEEDY 3 STEP allows you to get an **excellent level of glossy finish** on any type of floor with **less resources, less effort and in less time**. For optimal processing, we suggest to work with low-speed (450/500 rpm) and additional weight. After STEP 3 as last polishing step, we suggest to use HYPERPAD MAMBA (DRY) at maximum speed to clean the surface and increase the shine.

Ø 3"/75mm



STEP 1

**Speedy Step 1** with 3 metal segments inside the tool designed to quickly remove any grouting compounds and at the same time to open the floor, removing slight undulations and deep scratches on the floor. Its hybrid composition and the aggressive metal segments inside the tool allows to cut the surface and prepare the floor for the next step. Can be used Wet or Dry.

Ø 4"/100mm



STEP 1



STEP 2

**Speedy Step 2** transitional tool, designed to quickly remove scratches from the previous step and getting the surface smooth with slight satin effect. Its hybrid composition allows to start polishing the surfaces and prepare the floor for the last step. Can be used Wet or Dry.



STEP 2



STEP 3

**Speedy Step 3** final step designed to polishing the surface up to grit 800. Its hybrid composition allows to quickly remove any scratches and polishing perfectly the surface. The quality of the finish can be compared to the traditional resin tools grit 800. Can be used Wet or Dry.



STEP 3

### MAIN ADVANTAGES:

- Dry and Wet application
- Fast cutting and floor preparation
- High productivity
- Labour cost reduction
- Fast system: only 3 steps
- Easy to use
- Available 3"/75mm and 4"/100mm
- Eco-friendly

### DATA SHEET

<b>Suitable for</b>	Concrete / Marble / Terrazzo
<b>Bond</b>	Hybrid
<b>Composition</b>	Natural diamond
<b>Application</b>	Wet & Dry
<b>Connection</b>	Velcro support

DESCRIPTION	SIZE	THICKNESS	PRICE
SPEEDY STEP 1	3"/75mm	12mm	€ 67,50
SPEEDY STEP 2	3"/75mm	12mm	€ 24,50
SPEEDY STEP 3	3"/75mm	12mm	€ 24,50
SPEEDY STEP 1	4"/100mm	12mm	€ 80,00
SPEEDY STEP 2	4"/100mm	12mm	€ 27,50
SPEEDY STEP 3	4"/100mm	12mm	€ 27,50



# **HYPERPAD** **PLUS**

## **4 STEP** POLISHING SYSTEM

HYBRID FLOOR PADS FOR SOFT AND MEDIUM HARD SURFACES

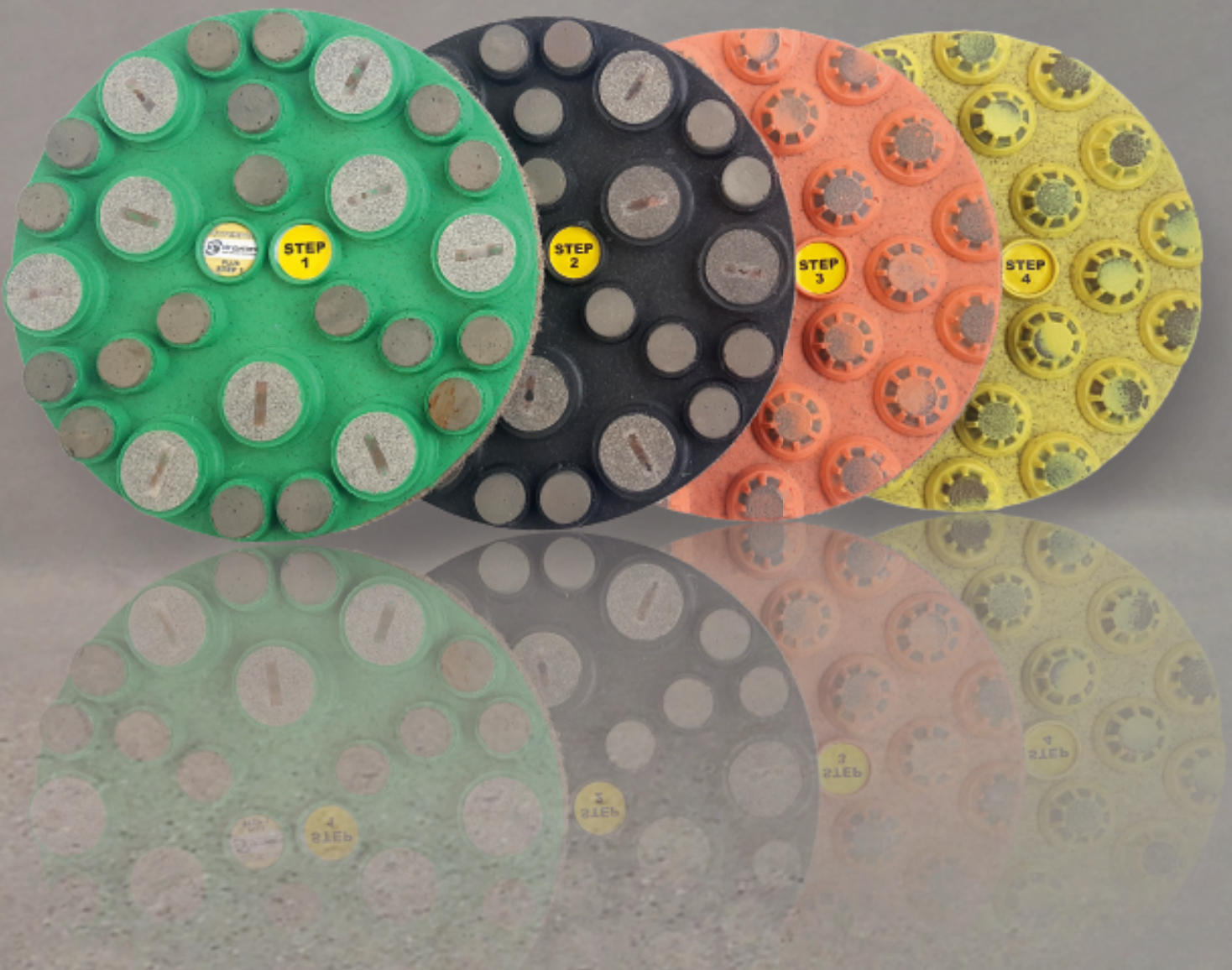

*suitable for*  
**CONCRETE, MARBLE AND TERRAZZO**

**HIGH PERFORMANCE - HIGH CUTTING - NO SCRATCHES**

STEP 1

STEP 2

STEP 3

STEP 4

## NEW 4 STEP POLISHING SYSTEM

### HYBRID FLOOR PADS SUITABLE FOR SOFT AND MEDIUM HARD SURFACES

**NEW 4 STEP** grinding and polishing system developed by Klinsystem, allows drastic reduction of grinding and polishing time and costs. Suitable for Soft and Abrasive Concrete, Marble and Terrazzo floors. Large increase of productivity preserving high quality standards.

**STEP 1** and **STEP 2** Tools with Hybrid METAL and RESIN bond designed for very fast and quick first floor grinding and levelling.

High performance, high cutting and SCRATCHES-FREE grinding also from the first step.

**STEP 3** and **STEP 4** Quick polishing process reduced in only 2 steps.

The flexible design allows continuous cutting even on unlevelled floor keeping always long lasting tools life. Easy Quick Tool Change with floor pad connection.

No flaw grinding and no diamond element grazing.

**HYPERPAD PLUS 4 STEP** allows you to get an excellent level of glossy finish on any type of floor with less resources, with less effort and in less time.

For optimal processing, we suggest to work with low-speed (450/500 rpm) and additional weight. After STEP 4 as last polishing step, we suggest to use HYPERPAD MAMBA (DRY) at maximum speed, to clean the surface and increase the shine.



STEP 1



## STEP 1

**Suitable for:** Soft Concrete / Marble / Terrazzo  
**Application:** Wet & Dry  
**Tool thickness:** 14mm

**Bond:** Hybrid metal and resin  
**Composition:** Natural diamond  
**Connection:** Floor pad

Size Ø 235mm

with 9 metal segments

€ 175,00



STEP 2



## STEP 2

**Suitable for:** Soft Concrete / Marble / Terrazzo  
**Application:** Wet & Dry  
**Tool thickness:** 14mm

**Bond:** Hybrid metal and resin  
**Composition:** Natural diamond  
**Connection:** Floor pad

Size Ø 235mm

with 9 metal segments

€ 175,00



STEP 3



## STEP 3

**Suitable for:** Soft Concrete / Marble / Terrazzo  
**Application:** Wet & Dry  
**Tool thickness:** 10mm

**Bond:** Hybrid resin bond  
**Composition:** Natural diamond  
**Connection:** Floor pad

Size Ø 235mm

without metal segments

€ 109,00



STEP 4



## STEP 4

**Suitable for:** Soft Concrete / Marble / Terrazzo  
**Application:** Wet & Dry  
**Tool thickness:** 10mm

**Bond:** Hybrid resin bond  
**Composition:** Natural diamond  
**Connection:** Floor pad

Size Ø 235mm

without metal segments

€ 109,00



# **HYPERPAD**

## **HARD**

### **4 STEP POLISHING SYSTEM**

**HYBRID FLOOR PADS FOR VERY HARD SURFACES**



*suitable for*

**HARD CONCRETE, TERRAZZO OVERLAY, GRANITE AND GRES**

**HIGH PERFORMANCE - HIGH CUTTING - NO SCRATCHES**

# HYPERPAD Hard



## NEW 4 STEP POLISHING SYSTEM HYBRID FLOOR PADS SUITABLE FOR VERY HARD SURFACES

**NEW 4 STEP** grinding and polishing system developed by Klinsystem which allows drastic reduction of grinding and polishing time and costs. Suitable for Very Hard Concrete, Terrazzo and Micro Terrazzo Overlay, Granite and Gres floors. Large increase of productivity preserving high quality standards.

**STEP 1** and **STEP 2** Tools with Hybrid METAL and RESIN bond designed for very fast and quick first floor grinding and levelling.

**STEP 3** and **STEP 4** Quick polishing process reduced in only 2 steps. High performance, high cutting and SCRATCHES-FREE grinding also from the first step. The flexible design allows continuous cutting even on unlevelled floor keeping always long lasting tools life. Easy Quick Tool Change with floor pad connection. No flaw grinding and no diamond element glazing.

**HYPERPAD HARD 4 STEP** allows you to get an excellent level of glossy finish on any type of floor with less resources, with less effort and in less time.

For optimal processing, we suggest to work with low-speed (450/500 rpm) and additional weight. After STEP 4 as last polishing step, we suggest to use HYPERPAD MAMBA (DRY) at maximum speed to clean the surface and increase the shine.

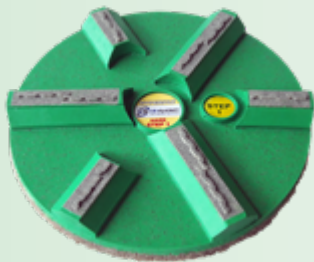

**STEP 1**



### STEP 1

**Suitable for:** Hard and Very Hard Concrete/  
Granite Terrazzo and Micro Terrazzo Overlay  
**Application:** Wet & Dry

**Bond:** Hybrid metal and resin  
**Composition:** Natural diamond  
**Connection:** Floor pad

**Size** Ø 235mm

with 6 metal segments

€ 195,00



**STEP 2**



### STEP 2

**Suitable for:** Hard and Very Hard Concrete/  
Granite Terrazzo and Micro Terrazzo Overlay  
**Application:** Wet & Dry

**Bond:** Hybrid metal and resin  
**Composition:** Natural diamond  
**Connection:** Floor pad

**Size** Ø 235mm

with 6 metal segments

€ 195,00



**STEP 3**



### STEP 3

**Suitable for:** Hard and Very Hard Concrete/  
Granite Terrazzo and Micro Terrazzo Overlay  
**Application:** Wet & Dry

**Bond:** Hybrid resin bond  
**Composition:** Natural diamond  
**Connection:** Floor pad

**Size** Ø 235mm

without metal segments

€ 109,00



**STEP 4**



### STEP 4

**Suitable for:** Hard and Very Hard Concrete/  
Granite Terrazzo and Micro Terrazzo Overlay  
**Application:** Wet & Dry

**Bond:** Hybrid resin bond  
**Composition:** Natural diamond  
**Connection:** Floor pad

**Size** Ø 235mm

without metal segments

€ 109,00



# **HYPERPAD**

## **SELF**

### **4 STEP** POLISHING SYSTEM

HYBRID FLOOR PADS FOR HARD SELF-LEVELING OVERLAY



*suitable for*  
**SELF-LEVELING OVERLAY LIKE ULTRATOP AND SIMILAR**  
**HIGH PERFORMANCE - HIGH CUTTING - NO SCRATCHES**

# HYPERPAD Self

STEP 1

STEP 2

STEP 3

STEP 4

## NEW 4 STEP POLISHING SYSTEM SUITABLE FOR HARD SELF-LEVELING OVERLAY LIKE ULTRATOP AND SIMILAR

**NEW 4 STEP** grinding and polishing system developed by Klinsystem which allows drastic reduction of grinding and polishing time and costs. Suitable for extremely Hard Concrete, Hard Self-leveling Overlay like Mapei UltraTop or similar products, Hard Micro Terrazzo and Terrazzo Overlay. Large increase of productivity preserving high quality standards.

**STEP 1** and **STEP 2** - Tools designed for very fast and quick first floor grinding and levelling.

**STEP 3** and **STEP 4** - Quick polishing process reduced in only 2 steps.

**SCRATCHES-FREE**, high performance grinding and polishing. The flexible design allows continuous cutting even on unlevelled floor keeping always long lasting tools life. Easy Quick Tool Change with floor pad connection. No flaw grinding and no diamond element glazing.

**HYPERPAD SELF** allows you to get an excellent level of glossy finish on extremely Hard Concrete, Hard Self-leveling Overlay like Mapei UltraTop or similar products, Hard Terrazzo and Micro Terrazzo Overlay with less resources, with less effort and in less time.

For optimal processing, we suggest to work with low-speed (450/500 rpm) and additional weight. After STEP 4 as last polishing step, we suggest to use HYPERPAD MAMBA (dry) at maximum speed to clean the surface and increase the shine.

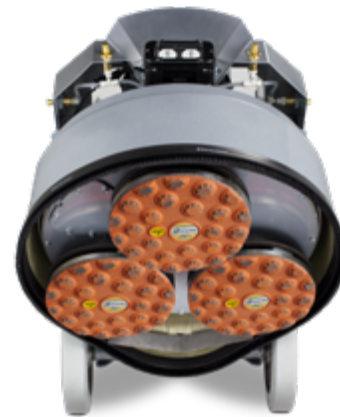

### DATA SHEET

<b>Suitable for</b>	Concrete Screeds / Hard Self-leveling Overlay
<b>Bond</b>	Hybrid resin bond
<b>Composition</b>	Natural diamond
<b>Application</b>	Wet & Dry
<b>Connection</b>	Floor pad

### DESCRIPTION

### SIZE

### PRICE

HYPERPAD SELF Step 1	235mm	€ 109,00
HYPERPAD SELF Step 2	235mm	€ 109,00
HYPERPAD SELF Step 3	235mm	€ 109,00
HYPERPAD SELF Step 4	235mm	€ 109,00

## HYPERPAD Mamba

### HIGH GLOSS POLISHING PAD WITH NATURAL DIAMOND

**HYPERPAD MAMBA** polishing pad developed by Klinsystem, thanks to its composition with a combination of Natural Diamonds grits 1500 and 3500, allows to clean and polishing the surface getting an extraordinary ultra gloss finish. Suitable for all kind of polished floors like Concrete, Marble, Granite and Self-leveling Overlay. Also suitable to remove resin diamond tool marks.

Large increase of productivity preserving high quality standards. Its flexible design allows continuous polishing even on unlevelled floors. High performance and long lasting polishing pad, allows to get high glossy finish with less effort and in less time.

For optimal processing with your planetary grinding machine, we suggest to use MAMBA after SPEEDY STEP 3 or HYPERPAD STEP 4 as last polishing step, DRY use at maximum speed to clean the surface and increase the shine.

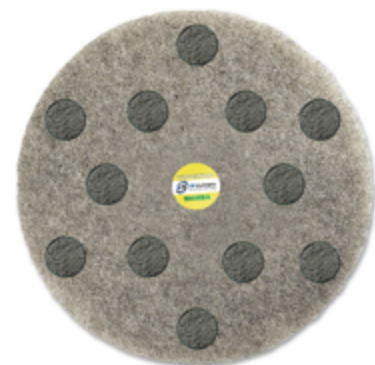

### DATA SHEET

<b>Suitable for</b>	All kind of concrete
<b>Bond</b>	Hybrid resin bond grit 1500/3500
<b>Composition</b>	Natural diamond
<b>Application</b>	Dry
<b>Connection</b>	Floor pad

### DESCRIPTION

### SIZE

### PRICE

HYPERPAD MAMBA	235mm	€ 60,00
----------------	-------	---------

# Hard Concrete POLISHING SYSTEM

## HARD CONCRETE IS A CONCRETE FLOOR POLISHING SYSTEM CREATED AND DEVELOPED BY THE COMPANY KLINSYSTEM.

Thanks to this new system now possible to transform your ordinary concrete floor into a new floor, decorative, not dust, nice to see, polished like mirror protected and very easy to clean and to maintain!

The HARD CONCRETE POLISHING SYSTEM is a MECHANICAL grinding and polishing system with no dangerous chemicals without application of wax or resin.

**WHAT IS HARD CONCRETE SYSTEM?** With HARD CONCRETE SYSTEM even an old, stained and worn floor can be treated to make it looks like new, extremely resistant, no dust, repellent to dirt, and very easy to clean. Transform your concrete floor in a beautiful surface like marble or granite looking which is strong as concrete. Floor will be shine, oil repellent and waterproof and is also possible coloring the surface and create logos.



### THE BEST OPTION AND THE BEST SOLUTION

- No dust, but allows to transpire the concrete slab
- Aesthetically comparable as marble or terrazzo flooring
- 5 times more resistant to wear than a standard concrete floor
- 5 times more resistant to traffic of forklifts (no scratches on the floor)
- More economic than any other traditional flooring with greater performance

### HARD CONCRETE COLOR SYSTEM

- Available in wide variety of colors and designs
- Versatility of the system
- High gloss finish
- Design Aesthetics



### MAIN ADVANTAGES

All resin surfaces have a low wear resistance and a very limited life. The concrete floor treated with HARD CONCRETE SYSTEM has no time limit, after the treatment lasts forever.

Thanks to this innovative system, you can turn any Industrial concrete floor into a modern mirror polished floor, that does not make dust, protected against water, oil and acid, traffic Wear resistant, hygienic, and beautiful to look like terrazzo floor. The concrete polishing system brings exceptional benefits. The maintenance of an old industrial floor during the years is considerably expensive. Grinding and polishing the industrial concrete floor makes it much more resistant to scratches and forklift traffic. The tires will not leave marks thanks to an excellent grip that makes the anti-slip floor.

These results are possible thanks to the use of consolidating products that increase the hardness of the cement by penetrating the floor and becoming part of it eliminating the problem of film formation.

**HARD CONCRETE SYSTEM** is ideal for all industrial concrete flooring, domestic structures, commercial structures and heavy traffic industrial flooring. The characteristics of HARD CONCRETE makes this system BEST than many other conventional systems such as resins, paints or waxes.



# Hard Concrete POLISHING SYSTEM



## BENEFITS OF HARD CONCRETE

HARD CONCRETE SYSTEM is great for small and large commercial environments with a wide range of different finishes. Hard Concrete System is a multi-step process, so you can choose the level of finish and the final effective cost.

- Elimination of height variances (Undulations)
- Consolidation of concrete with special chemicals eco-friendly
- The floor become 5 timer harder and resistant to the traffic of heavy trolley and vehicles
- Process of reaction & reparation to remove inherent defects
- Honing to provide uniform & polished finish
- High Protection with Nano Technology
- NO DUST / NO STAIN
- Obtaining of high gloss finish, shine, brilliance
- Water, Acid and Oil repellent

## MAIN FEATURES

- **NO DUST:** it doesn't produce dust, dirt, allergens. Resistant to moisture transmission problems: It allows the floor to breathe and eliminates problems arise with other flooring materials that seal the concrete, such as tile, resin etc.
- **LOW MAINTENANCE:** extremely low maintenance, convenient, allows you to create an eco-friendly work environment for employees.
- **NO FORKLIFT TRUCK SIGNS:** The smooth, polished surface resists the signs of forklift tires and protects against oil spills and chemical spills.
- **ECONOMIC AND COST SAVINGS** (no additional coatings) traditional flooring materials such as resins and waxes are not necessary where the concrete slab is used directly as the finished floor surface.
- **DURATION:** highly resistant to trampling and heavy industrial machinery traffic. Much more resistant to stains.
- **ECO-FRIENDLY:** sustainable flooring alternative. It requires no hazardous coatings, detergents and adhesives.
- **HIGH LIGHT REFRACTION:** The polished concrete surface reflects the light. Important for offices, buildings, stores, deposits of materials, big shopping areas, hotels hall, restaurants, public facilities that want to project a professional bright and clean image.
- **SAVING ELECTRICITY:** reducing artificial lighting use, especially in large areas.



## CONSOLIDATION AND HARDENING

The concrete floor, treated with silicates has similar characteristics to a granite floor and can be subjected to similar grinding procedures. After the treatment, the concrete floor can be grinded until becoming mechanically polished. Polished concrete is not the result of applying a polishing product but a professional process of grinding and polishing. Polishing concrete with the HARD Concrete system means transforming your industrial floor forever.

## APPLICATIONS

- It can be used for public projects, universities, schools, hospitals, stadiums etc.
- Increases the hardness and the resistance to the abrasion of your concrete floor
- Stain-resistant, oil and water-repellent
- Definitely Block the dust from concrete slab
- Extremely economic for big projects, for commercial and industrial areas
- It requires very low maintenance - Ecological (V.O.C. FREE)
- Allow the floor to breathe to prevent peeling
- It lasts 10 times longer than any resin floor



# Hard Concrete POLISHING SYSTEM



## HARD CONCRETE PRIME

Developed by Klinsystem and suitable for both residential and industrial surfaces. Full step high quality floor grinding and polishing system without exposing the aggregate, includes cracks and holes repairing, high planarity, deep gloss polishing, stain resistant, oil protection and water repellent, modern look, wide range of colours available.

## HARD CONCRETE 4 STEP

The fastest way to turn a normal concrete floor, into a new shiny, hard and resistant surface. The latest hybrid technology for concrete grinding and polishing to achieve the best results while saving time, effort and money. Klinsystem provides a wide range of hybrid tools like speedy 3 step and hyperpad 4 STEP. The hybrid technology allows to save time and money always getting the best quality finish.

## HARD CONCRETE TERRAZZO

Deep grinding and polishing system with full exposure of aggregates, high planarity and regularity of the floor. Includes cracks and holes repairing, high planarity, deep gloss polishing, stain resistant, oil protection and water repellent. Hard Concrete Terrazzo offers a wide variety of colour options and contemporary look. Suitable for both residential and industrial floors.

## TROWEL SHINE SYSTEM

With the new Klinsystem Polishing System is possible to polish up to 2000 square meters per day! Using the power-trowel and the new Klinsystem diamond tools, is now possible turn an industrial floated floor into a beautiful surface, durable, stain-resistant, glossy and easy-to-clean floor.

Suitable for big industrial or commercial areas.

*More information pag. 36-37.*

# Hard Concrete POLISHING SYSTEM



Transform your floor into an indestructible and durable surface suitable for any use. The HARD CONCRETE system developed by Klinsystem transforms your ordinary concrete into a mirror-polished concrete floor, protected, no-scratch, no-dust, stain resistant and easy-to-clean.

The procedure to transform the concrete floor sometimes includes to remove old resin or old coatings from the floor using specific diamond tools. Then is possible to grinding the concrete floor with several steps until the surface become smooth and flat. During the process is important the consolidation of the surface using specific Klinsystem products as **Concrete Hardner** and **Concrete Hardner Lithium**. Then finally is possible to obtain an optimal closure of the porosity of the floor.

The surface become up to 8 times harder and resistant to the abrasion. Once the surface has been polished, is possible to treat the floor with water and oil repellent products as **Concrete Guard Lithium** and **Concrete Gloss**, in order to increase the resistance of the concrete and make it dust proof - water proof and oil repellent. The whole process allows to obtain a glossy surface which is at the same time no-slip and resistant to external agents and heavy traffic.



# Coating Removal

## PROFESSIONAL QUICK CHANGE TOOLS RANGE suitable for all floor grinders on the market



### **CAX** METAL BOND DIAMOND TOOLS FOR VERY ABRASIVE CONCRETE

Suitable for floor preparation, floor levelling and coating removal

	DESCRIPTION					PRICE
	<b>KS CAX00</b>	GRIT 14/24	trapezoid	2 segments	Quick Change	€ 69,00
	<b>KS CAX0</b>	GRIT 36/40	trapezoid	2 segments	Quick Change	€ 66,00
	<b>KS CAX1</b>	GRIT 70/80	trapezoid	2 segments	Quick Change	€ 66,00
	<b>KS CAX2</b>	GRIT 120	trapezoid	2 segments	Quick Change	€ 66,00
	<b>KS CAX00</b>	GRIT 14/24	trapezoid	1 segment	Quick Change	€ 49,00
	<b>KS CAX0</b>	GRIT 36/40	trapezoid	1 segment	Quick Change	€ 45,00
	<b>KS CAX1</b>	GRIT 70/80	trapezoid	1 segment	Quick Change	€ 45,00
	<b>KS CAX2</b>	GRIT 120	trapezoid	1 segment	Quick Change	€ 45,00

### **CA** METAL BOND DIAMOND TOOLS FOR ABRASIVE CONCRETE

Suitable for floor preparation, floor levelling and coating removal

	DESCRIPTION					PRICE
	<b>KS CA00</b>	GRIT 14/24	trapezoid	2 segments	Quick Change	€ 69,00
	<b>KS CA0</b>	GRIT 36/40	trapezoid	2 segments	Quick Change	€ 66,00
	<b>KS CA1</b>	GRIT 70/80	trapezoid	2 segments	Quick Change	€ 66,00
	<b>KS CA2</b>	GRIT 120	trapezoid	2 segments	Quick Change	€ 66,00
	<b>KS CA00</b>	GRIT 14/24	trapezoid	1 segment	Quick Change	€ 49,00
	<b>KS CA0</b>	GRIT 36/40	trapezoid	1 segment	Quick Change	€ 45,00
	<b>KS CA1</b>	GRIT 70/80	trapezoid	1 segment	Quick Change	€ 45,00
	<b>KS CA2</b>	GRIT 120	trapezoid	1 segment	Quick Change	€ 45,00

# Coating Removal

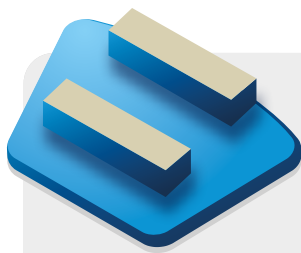

**00 BLUE**  
Extra Coarse

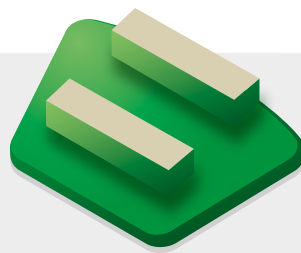

**0 GREEN**  
Coarse

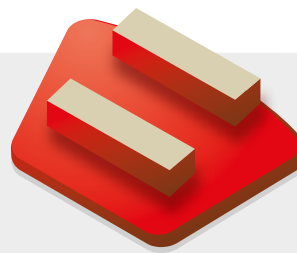

**1 RED**  
Medium

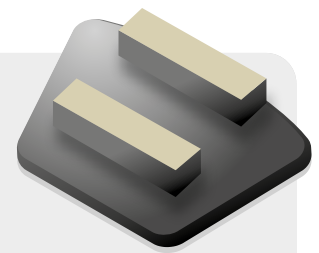

**2 BLACK**  
Fine

## CS

### METAL BOND DIAMOND TOOLS FOR STANDARD CONCRETE

Suitable for floor preparation, floor levelling and coating removal

DESCRIPTION		PRICE
	<b>KS CS00</b> GRIT 14/24 trapezoid <b>2 segments</b> Quick Change	€ 69,00
	<b>KS CS0</b> GRIT 36/40 trapezoid <b>2 segments</b> Quick Change	€ 66,00
	<b>KS CS1</b> GRIT 70/80 trapezoid <b>2 segments</b> Quick Change	€ 66,00
	<b>KS CS2</b> GRIT 120 trapezoid <b>2 segments</b> Quick Change	€ 66,00
	<b>KS CS00</b> GRIT 14/24 trapezoid <b>1 segment</b> Quick Change	€ 49,00
	<b>KS CS0</b> GRIT 36/40 trapezoid <b>1 segment</b> Quick Change	€ 45,00
	<b>KS CS1</b> GRIT 70/80 trapezoid <b>1 segment</b> Quick Change	€ 45,00
	<b>KS CS2</b> GRIT 120 trapezoid <b>1 segment</b> Quick Change	€ 45,00

## CD

### METAL BOND DIAMOND TOOLS FOR HARD CONCRETE

Suitable for floor preparation, floor levelling and coating removal

DESCRIPTION		PRICE
	<b>KS CD00</b> GRIT 14/24 trapezoid <b>2 segments</b> Quick Change	€ 69,00
	<b>KS CD0</b> GRIT 36/40 trapezoid <b>2 segments</b> Quick Change	€ 66,00
	<b>KS CD1</b> GRIT 70/80 trapezoid <b>2 segments</b> Quick Change	€ 66,00
	<b>KS CD2</b> GRIT 120 trapezoid <b>2 segments</b> Quick Change	€ 66,00
	<b>KS CD00</b> GRIT 14/24 trapezoid <b>1 segment</b> Quick Change	€ 49,00
	<b>KS CD0</b> GRIT 36/40 trapezoid <b>1 segment</b> Quick Change	€ 45,00
	<b>KS CD1</b> GRIT 70/80 trapezoid <b>1 segment</b> Quick Change	€ 45,00
	<b>KS CD2</b> GRIT 120 trapezoid <b>1 segment</b> Quick Change	€ 45,00

## CDX

### METAL BOND DIAMOND TOOLS FOR EXTRA HARD CONCRETE

Suitable for floor preparation, floor levelling and coating removal





DESCRIPTION		PRICE
	<b>KS CDX00</b> GRIT 14/24 trapezoid <b>2 segments</b> Quick Change	€ 69,00
	<b>KS CDX0</b> GRIT 36/40 trapezoid <b>2 segments</b> Quick Change	€ 66,00
	<b>KS CDX1</b> GRIT 70/80 trapezoid <b>2 segments</b> Quick Change	€ 66,00
	<b>KS CDX2</b> GRIT 120 trapezoid <b>2 segments</b> Quick Change	€ 66,00
	<b>KS CDX00</b> GRIT 14/24 trapezoid <b>1 segment</b> Quick Change	€ 49,00
	<b>KS CDX0</b> GRIT 36/40 trapezoid <b>1 segment</b> Quick Change	€ 45,00
	<b>KS CDX1</b> GRIT 70/80 trapezoid <b>1 segment</b> Quick Change	€ 45,00
	<b>KS CDX2</b> GRIT 120 trapezoid <b>1 segment</b> Quick Change	€ 45,00

# Floor Preparation

## KS DA

### METAL BOND DIAMOND TOOLS FOR MEDIUM ABRASIVE CONCRETE



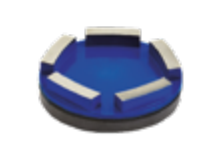

Suitable for floor preparation, coating removal, floor levelling and floor grinding and polishing

	DESCRIPTION					PRICE
	<b>KS DA00</b>	GRIT 24	Ø 240mm - 9,5"	12 segments	Quick Change	€ 270,00
	<b>KS DA0</b>	GRIT 36	Ø 240mm - 9,5"	12 segments	Quick Change	€ 190,00
	<b>KS DA1</b>	GRIT 60	Ø 240mm - 9,5"	12 segments	Quick Change	€ 190,00
	<b>KS DA2</b>	GRIT 120	Ø 240mm - 9,5"	12 segments	Quick Change	€ 190,00
	<b>KS DA00</b>	GRIT 24	Ø 240mm - 9,5"	6 segments	Quick Change	€ 164,00
	<b>KS DA0</b>	GRIT 36	Ø 240mm - 9,5"	6 segments	Quick Change	€ 134,00
	<b>KS DA1</b>	GRIT 60	Ø 240mm - 9,5"	6 segments	Quick Change	€ 134,00
	<b>KS DA2</b>	GRIT 120	Ø 240mm - 9,5"	6 segments	Quick Change	€ 134,00
	<b>KS DA00</b>	GRIT 24	Ø 200mm - 8"	6 segments	Quick Change	€ 161,00
	<b>KS DA0</b>	GRIT 36	Ø 200mm - 8"	6 segments	Quick Change	€ 125,00
	<b>KS DA1</b>	GRIT 60	Ø 200mm - 8"	6 segments	Quick Change	€ 125,00
	<b>KS DA2</b>	GRIT 120	Ø 200mm - 8"	6 segments	Quick Change	€ 125,00
	<b>KS DA00</b>	GRIT 24	Ø 140mm - 5,5"	5 segments	Plastic Support	€ 128,00
	<b>KS DA0</b>	GRIT 36	Ø 140mm - 5,5"	5 segments	Plastic Support	€ 118,00
	<b>KS DA1</b>	GRIT 60	Ø 140mm - 5,5"	5 segments	Plastic Support	€ 118,00
	<b>KS DA2</b>	GRIT 120	Ø 140mm - 5,5"	5 segments	Plastic Support	€ 118,00
	<b>KS DA00</b>	GRIT 24	Ø 100mm - 4"	5 segments	Plastic Support	€ 124,00
	<b>KS DA0</b>	GRIT 36	Ø 100mm - 4"	5 segments	Plastic Support	€ 115,00
	<b>KS DA1</b>	GRIT 60	Ø 100mm - 4"	5 segments	Plastic Support	€ 115,00
	<b>KS DA2</b>	GRIT 120	Ø 100mm - 4"	5 segments	Plastic Support	€ 115,00

## KS CD

### METAL BOND DIAMOND TOOLS FOR HARD CONCRETE







Suitable for floor preparation, coating removal, floor levelling and concrete grinding and polishing

	DESCRIPTION					PRICE
	<b>KS CD00</b>	GRIT 24	Ø 240mm - 9,5"	6 segments	Quick Change	€ 170,00
	<b>KS CD0</b>	GRIT 36	Ø 240mm - 9,5"	6 segments	Quick Change	€ 150,00
	<b>KS CD1</b>	GRIT 60	Ø 240mm - 9,5"	6 segments	Quick Change	€ 140,00
	<b>KS CD2</b>	GRIT 120	Ø 240mm - 9,5"	6 segments	Quick Change	€ 140,00
	<b>KS CD00</b>	GRIT 24	Ø 240mm - 9,5"	4 segments	Quick Change	€ 140,00
	<b>KS CD0</b>	GRIT 36	Ø 240mm - 9,5"	4 segments	Quick Change	€ 125,00
	<b>KS CD1</b>	GRIT 60	Ø 240mm - 9,5"	4 segments	Quick Change	€ 125,00
	<b>KS CD2</b>	GRIT 120	Ø 240mm - 9,5"	4 segments	Quick Change	€ 125,00
	<b>KS CD00</b>	GRIT 24	Ø 200mm - 8"	4 segments	Quick Change	€ 140,00
	<b>KS CD0</b>	GRIT 36	Ø 200mm - 8"	4 segments	Quick Change	€ 125,00
	<b>KS CD1</b>	GRIT 60	Ø 200mm - 8"	4 segments	Quick Change	€ 115,00
	<b>KS CD2</b>	GRIT 120	Ø 200mm - 8"	4 segments	Quick Change	€ 115,00
	<b>KS CD00</b>	GRIT 24	Ø 140mm - 5,5"	4 segments	Plastic Support	€ 115,00
	<b>KS CD0</b>	GRIT 36	Ø 140mm - 5,5"	4 segments	Plastic Support	€ 95,00
	<b>KS CD1</b>	GRIT 60	Ø 140mm - 5,5"	4 segments	Plastic Support	€ 95,00
	<b>KS CD2</b>	GRIT 120	Ø 140mm - 5,5"	4 segments	Plastic Support	€ 95,00
	<b>KS CD00</b>	GRIT 24	Ø 100mm - 4"	4 segments	Plastic Support	€ 105,00
	<b>KS CD0</b>	GRIT 36	Ø 100mm - 4"	4 segments	Plastic Support	€ 95,00
	<b>KS CD1</b>	GRIT 60	Ø 100mm - 4"	4 segments	Plastic Support	€ 90,00
	<b>KS CD2</b>	GRIT 120	Ø 100mm - 4"	4 segments	Plastic Support	€ 90,00

## KS CA

### METAL BOND DIAMOND TOOLS FOR ABRASIVE CONCRETE

Suitable for floor preparation, coating removal, floor levelling and floor grinding and polishing

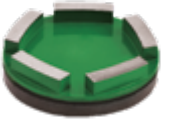
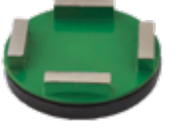
	DESCRIPTION					PRICE
	<b>KS CA00</b>	GRIT 24	Ø 240mm - 9,5"	<b>12 segments</b>	Quick Change	€ 305,00
	<b>KS CA0</b>	GRIT 36	Ø 240mm - 9,5"	<b>12 segments</b>	Quick Change	€ 285,00
	<b>KS CA1</b>	GRIT 60	Ø 240mm - 9,5"	<b>12 segments</b>	Quick Change	€ 265,00
	<b>KS CA2</b>	GRIT 120	Ø 240mm - 9,5"	<b>12 segments</b>	Quick Change	€ 265,00
	<b>KS CA00</b>	GRIT 24	Ø 240mm - 9,5"	<b>6 segments</b>	Quick Change	€ 201,50
	<b>KS CA0</b>	GRIT 36	Ø 240mm - 9,5"	<b>6 segments</b>	Quick Change	€ 184,50
	<b>KS CA1</b>	GRIT 60	Ø 240mm - 9,5"	<b>6 segments</b>	Quick Change	€ 172,00
	<b>KS CA2</b>	GRIT 120	Ø 240mm - 9,5"	<b>6 segments</b>	Quick Change	€ 155,50
	<b>KS CA00</b>	GRIT 24	Ø 200mm - 8"	<b>6 segments</b>	Quick Change	€ 185,00
	<b>KS CA0</b>	GRIT 36	Ø 200mm - 8"	<b>6 segments</b>	Quick Change	€ 176,00
	<b>KS CA1</b>	GRIT 60	Ø 200mm - 8"	<b>6 segments</b>	Quick Change	€ 166,00
	<b>KS CA2</b>	GRIT 120	Ø 200mm - 8"	<b>6 segments</b>	Quick Change	€ 160,00
	<b>KSCA00</b>	GRIT 24	Ø 200mm - 8"	<b>4 segments</b>	Quick Change	€ 148,00
	<b>KSCA0</b>	GRIT 36	Ø 200mm - 8"	<b>4 segments</b>	Quick Change	€ 142,00
	<b>KSCA1</b>	GRIT 60	Ø 200mm - 8"	<b>4 segments</b>	Quick Change	€ 140,00
	<b>KSCA2</b>	GRIT 120	Ø 200mm - 8"	<b>4 segments</b>	Quick Change	€ 135,00
	<b>KS CA00</b>	GRIT 24	Ø 140mm - 5,5"	<b>5 segments</b>	Plastic Support	€ 149,50
	<b>KS CA0</b>	GRIT 36	Ø 140mm - 5,5"	<b>5 segments</b>	Plastic Support	€ 139,00
	<b>KS CA1</b>	GRIT 60	Ø 140mm - 5,5"	<b>5 segments</b>	Plastic Support	€ 129,00
	<b>KS CA2</b>	GRIT 120	Ø 140mm - 5,5"	<b>5 segments</b>	Plastic Support	€ 129,00
	<b>KS CA00</b>	GRIT 24	Ø 140mm - 5,5"	<b>4 segments</b>	Plastic Support	€ 130,00
	<b>KS CA0</b>	GRIT 36	Ø 140mm - 5,5"	<b>4 segments</b>	Plastic Support	€ 120,00
	<b>KS CA1</b>	GRIT 60	Ø 140mm - 5,5"	<b>4 segments</b>	Plastic Support	€ 110,00
	<b>KS CA2</b>	GRIT 120	Ø 140mm - 5,5"	<b>4 segments</b>	Plastic Support	€ 105,00
	<b>KS CA00</b>	GRIT 24	Ø 100mm - 4"	<b>5 segments</b>	Plastic Support	€ 143,00
	<b>KS CA0</b>	GRIT 36	Ø 100mm - 4"	<b>5 segments</b>	Plastic Support	€ 133,50
	<b>KS CA1</b>	GRIT 60	Ø 100mm - 4"	<b>5 segments</b>	Plastic Support	€ 129,00
	<b>KS CA2</b>	GRIT 120	Ø 100mm - 4"	<b>5 segments</b>	Plastic Support	€ 129,00
	<b>KS CA00</b>	GRIT 24	Ø 100mm - 4"	<b>4 segments</b>	Plastic Support	€ 122,00
	<b>KS CA0</b>	GRIT 36	Ø 100mm - 4"	<b>4 segments</b>	Plastic Support	€ 115,00
	<b>KS CA1</b>	GRIT 60	Ø 100mm - 4"	<b>4 segments</b>	Plastic Support	€ 98,00
	<b>KS CA2</b>	GRIT 120	Ø 100mm - 4"	<b>4 segments</b>	Plastic Support	€ 98,00



# Floor Preparation

## KS CAX

### METAL BOND DIAMOND TOOLS FOR VERY ABRASIVE CONCRETE

Suitable for floor preparation, floor levelling and coating removal

	DESCRIPTION					PRICE
	<b>KS CAX00</b>	GRIT 24	Ø 240mm - 9,5"	12 segments	Quick Change	€ 355,00
	<b>KS CAX0</b>	GRIT 36	Ø 240mm - 9,5"	12 segments	Quick Change	€ 320,00
	<b>KS CAX00</b>	GRIT 24	Ø 240mm - 9,5"	6 segments	Quick Change	€ 216,00
	<b>KS CAX0</b>	GRIT 36	Ø 240mm - 9,5"	6 segments	Quick Change	€ 197,00
	<b>KS CAX00</b>	GRIT 24	Ø 200mm - 8"	6 segments	Quick Change	€ 206,00
	<b>KS CAX0</b>	GRIT 36	Ø 200mm - 8"	6 segments	Quick Change	€ 188,00
	<b>KS CAX00</b>	GRIT 24	Ø 200mm - 8"	4 segments	Quick Change	€ 160,00
	<b>KS CAX0</b>	GRIT 36	Ø 200mm - 8"	4 segments	Quick Change	€ 149,00
	<b>KS CAX00</b>	GRIT 24	Ø 140mm - 5,5"	5 segments	Plastic Support	€ 164,00
	<b>KS CAX0</b>	GRIT 36	Ø 140mm - 5,5"	5 segments	Plastic Support	€ 154,00
	<b>KS CAX00</b>	GRIT 24	Ø 140mm - 5,5"	4 segments	Plastic Support	€ 142,00
	<b>KS CAX0</b>	GRIT 36	Ø 140mm - 5,5"	4 segments	Plastic Support	€ 132,00
	<b>KS CAX00</b>	GRIT 24	Ø 100mm - 4"	5 segments	Plastic Support	€ 145,00
	<b>KS CAX0</b>	GRIT 36	Ø 100mm - 4"	5 segments	Plastic Support	€ 136,00
	<b>KS CAX00</b>	GRIT 24	Ø 100mm - 4"	4 segments	Plastic Support	€ 136,00
	<b>KS CAX0</b>	GRIT 36	Ø 100mm - 4"	4 segments	Plastic Support	€ 126,00







# Floor Preparation

## KS BT

### METAL BOND DIAMOND TOOLS WITH ROUND SEGMENTS

Suitable for concrete grinding and to remove resin coating and glue





		DESCRIPTION					PRICE
	<b>KS BT00</b>	GRIT 24	Ø 240mm - 9,5"	6 segments	Quick Change	€ 151,00	
	<b>KS BT0</b>	GRIT 36	Ø 240mm - 9,5"	6 segments	Quick Change	€ 151,00	
	<b>KS BT00</b>	GRIT 24	Ø 200mm - 8"	5 segments	Quick Change	€ 136,00	
	<b>KS BT0</b>	GRIT 36	Ø 200mm - 8"	5 segments	Quick Change	€ 136,00	
	<b>KS BT00</b>	GRIT 24	Ø 140mm - 5,5"	4 segments	Plastic Support	€ 105,00	
	<b>KS BT0</b>	GRIT 36	Ø 140mm - 5,5"	4 segments	Plastic Support	€ 105,00	
	<b>KS BT00</b>	GRIT 24	Ø 100mm - 4"	4 segments	Plastic Support	€ 100,00	
	<b>KS BT0</b>	GRIT 36	Ø 100mm - 4"	4 segments	Plastic Support	€ 100,00	

## KS TCD

### METAL BOND DIAMOND TOOLS FOR VERY ABRASIVE CONCRETE

Suitable for floor preparation, floor levelling and coating removal

Very hard bond with special diamond for fast and durable grinding on soft and abrasive concrete

		DESCRIPTION					PRICE
	<b>KS TCD000</b>	GRIT 24	Ø 240mm - 9,5"	6 segments	Quick Change	€ 227,00	
	<b>KS TCD00</b>	GRIT 36	Ø 240mm - 9,5"	6 segments	Quick Change	€ 215,00	
	<b>KS TCD0</b>	GRIT 60	Ø 240mm - 9,5"	6 segments	Quick Change	€ 155,00	
	<b>KS TCD000</b>	GRIT 24	Ø 200mm - 8"	6 segments	Quick Change	€ 218,00	
	<b>KS TCD00</b>	GRIT 36	Ø 200mm - 8"	6 segments	Quick Change	€ 205,00	
	<b>KS TCD0</b>	GRIT 60	Ø 200mm - 8"	6 segments	Quick Change	€ 148,00	
	<b>KS TCD000</b>	GRIT 24	Ø 140mm - 5,5"	5 segments	Plastic Support	€ 180,00	
	<b>KS TCD00</b>	GRIT 36	Ø 140mm - 5,5"	5 segments	Plastic Support	€ 167,00	
	<b>KS TCD0</b>	GRIT 60	Ø 140mm - 5,5"	5 segments	Plastic Support	€ 119,00	
	<b>KS TCD000</b>	GRIT 24	Ø 100mm - 4"	4 segments	Plastic Support	€ 148,00	
	<b>KS TCD00</b>	GRIT 36	Ø 100mm - 4"	4 segments	Plastic Support	€ 132,00	
	<b>KS TCD0</b>	GRIT 60	Ø 100mm - 4"	4 segments	Plastic Support	€ 98,00	

# Polished Concrete System





## RESIN BOND DIAMOND TOOLS

For Polishing Concrete System suitable for any kind of industrial concrete floors





DESCRIPTION					PRICE
	<b>JUMPFLEX CONCRETE 3</b>	GRIT 60	Ø 75mm – 3"	Velcro connection	€ 18,50
	<b>JUMPFLEX CONCRETE 4</b>	GRIT 120	Ø 75mm – 3"	Velcro connection	€ 18,50
	<b>JUMPFLEX CONCRETE 5</b>	GRIT 220	Ø 75mm – 3"	Velcro connection	€ 18,50
	<b>JUMPFLEX CONCRETE 6</b>	GRIT 400	Ø 75mm – 3"	Velcro connection	€ 18,50
	<b>JUMPFLEX CONCRETE 7</b>	GRIT 800	Ø 75mm – 3"	Velcro connection	€ 18,50
	<b>JUMPFLEX CONCRETE 8</b>	GRIT 1800	Ø 75mm – 3"	Velcro connection	€ 18,50
	<b>JUMPFLEX CONCRETE 3</b>	GRIT 60	Ø 100mm – 4"	Velcro connection	€ 28,50
	<b>JUMPFLEX CONCRETE 4</b>	GRIT 120	Ø 100mm – 4"	Velcro connection	€ 28,50
	<b>JUMPFLEX CONCRETE 5</b>	GRIT 220	Ø 100mm – 4"	Velcro connection	€ 28,50
	<b>JUMPFLEX CONCRETE 6</b>	GRIT 400	Ø 100mm – 4"	Velcro connection	€ 28,50
	<b>JUMPFLEX CONCRETE 7</b>	GRIT 800	Ø 100mm – 4"	Velcro connection	€ 28,50
	<b>JUMPFLEX CONCRETE 8</b>	GRIT 1800	Ø 100mm – 4"	Velcro connection	€ 28,50
	<b>CONDOR CONCRETE 3</b>	GRIT 60	Ø 75mm – 3"	Velcro connection	€ 15,00
	<b>CONDOR CONCRETE 4</b>	GRIT 120	Ø 75mm – 3"	Velcro connection	€ 15,00
	<b>CONDOR CONCRETE 5</b>	GRIT 220	Ø 75mm – 3"	Velcro connection	€ 15,00
	<b>CONDOR CONCRETE 6</b>	GRIT 400	Ø 75mm – 3"	Velcro connection	€ 15,00
	<b>CONDOR CONCRETE 7</b>	GRIT 800	Ø 75mm – 3"	Velcro connection	€ 15,00
	<b>CONDOR CONCRETE 8</b>	GRIT 1800	Ø 75mm – 3"	Velcro connection	€ 15,00
	<b>CONDOR CONCRETE 3</b>	GRIT 60	Ø 100mm – 4"	Velcro connection	€ 22,00
	<b>CONDOR CONCRETE 4</b>	GRIT 120	Ø 100mm – 4"	Velcro connection	€ 22,00
	<b>CONDOR CONCRETE 5</b>	GRIT 220	Ø 100mm – 4"	Velcro connection	€ 22,00
	<b>CONDOR CONCRETE 6</b>	GRIT 400	Ø 100mm – 4"	Velcro connection	€ 22,00
	<b>CONDOR CONCRETE 7</b>	GRIT 800	Ø 100mm – 4"	Velcro connection	€ 22,00
	<b>CONDOR CONCRETE 8</b>	GRIT 1800	Ø 100mm – 4"	Velcro connection	€ 22,00
	<b>C-KS 3</b>	GRIT 60	Ø 100mm – 4"	Plastic support connection	€ 45,00
	<b>C-KS 4</b>	GRIT 120	Ø 100mm – 4"	Plastic support connection	€ 45,00
	<b>C-KS 5</b>	GRIT 220	Ø 100mm – 4"	Plastic support connection	€ 45,00
	<b>C-KS 6</b>	GRIT 400	Ø 100mm – 4"	Plastic support connection	€ 45,00
	<b>C-KS 7</b>	GRIT 800	Ø 100mm – 4"	Plastic support connection	€ 45,00
	<b>C-KS 8</b>	GRIT 1800	Ø 100mm – 4"	Plastic support connection	€ 45,00
	<b>C-KS 3 140mm</b>	GRIT 60	Ø 140mm – 5,5"	Velcro connection	€ 55,00
	<b>C-KS 4 140mm</b>	GRIT 120	Ø 140mm – 5,5"	Velcro connection	€ 55,00
	<b>C-KS 5 140mm</b>	GRIT 220	Ø 140mm – 5,5"	Velcro connection	€ 55,00
	<b>C-KS 6 140mm</b>	GRIT 400	Ø 140mm – 5,5"	Velcro connection	€ 55,00
	<b>C-KS 7 140mm</b>	GRIT 800	Ø 140mm – 5,5"	Velcro connection	€ 55,00
	<b>C-KS 8 140mm</b>	GRIT 1800	Ø 140mm – 5,5"	Velcro connection	€ 55,00
	<b>COUGARFLEX CONCRETE 3</b>	GRIT 60	Ø 125mm – 5"	Velcro connection	€ 48,00
	<b>COUGARFLEX CONCRETE 4</b>	GRIT 120	Ø 125mm – 5"	Velcro connection	€ 48,00
	<b>COUGARFLEX CONCRETE 5</b>	GRIT 220	Ø 125mm – 5"	Velcro connection	€ 48,00
	<b>COUGARFLEX CONCRETE 6</b>	GRIT 400	Ø 125mm – 5"	Velcro connection	€ 48,00
	<b>COUGARFLEX CONCRETE 7</b>	GRIT 800	Ø 125mm – 5"	Velcro connection	€ 48,00
	<b>COUGARFLEX CONCRETE 8</b>	GRIT 1800	Ø 125mm – 5"	Velcro connection	€ 48,00
	<b>COUGARFLEX CONCRETE 3</b>	GRIT 60	Ø 150mm – 6"	Velcro connection	€ 39,00
	<b>COUGARFLEX CONCRETE 4</b>	GRIT 120	Ø 150mm – 6"	Velcro connection	€ 39,00
	<b>COUGARFLEX CONCRETE 5</b>	GRIT 220	Ø 150mm – 6"	Velcro connection	€ 39,00
	<b>COUGARFLEX CONCRETE 6</b>	GRIT 400	Ø 150mm – 6"	Velcro connection	€ 39,00
	<b>COUGARFLEX CONCRETE 7</b>	GRIT 800	Ø 150mm – 6"	Velcro connection	€ 39,00
	<b>COUGARFLEX CONCRETE 8</b>	GRIT 1800	Ø 150mm – 6"	Velcro connection	€ 39,00

COUGARFLEX CONCRETE: Available also 100mm - 4" / 140mm - 5,5"

# Products FOR CONCRETE SYSTEM

	DESCRIPTION	PRICE								
	<p><b>CONCRETE HARDNER (Sodium / Potassium densifier)</b> Concrete Hardner KS10 improves the hardness and quality of new and existing concrete floors. Easy-to-use water-based solution. When sprayed on new or existing concrete, it penetrates up to 4mm where it reacts with free calcium to form insoluble calcium silica hydrate, which makes concrete water, stain and abrasion resistant for easier maintenance and longer life. It is also suitable for concrete polishing procedures and helps prolong the life of polished finishes.</p> <p><b>Concrete Hardner KS 10 Lt 5 (mixing ratio 1:3)</b></p> <p><b>Concrete Hardner KS 10 Lt 25 (mixing ratio 1:3)</b></p> <p><b>Concrete Hardner KS 35 Lt 25 (mixing ratio 1:2)</b></p>	<p>€ 49,50</p> <p>€ 215,00</p> <p>€ 159,00</p>								
	<p><b>CONCRETE HARDNER LITHIUM (Lithium densifier)</b> Concrete Hardner Lithium improves the hardness and quality of new and existing concrete floors. Easy-to-use water-based solution. When sprayed on new or existing concrete, it penetrates up to 7mm where it reacts with free calcium to form insoluble calcium silica hydrate, which makes concrete water, stain and abrasion resistant for easier maintenance and longer life. It is also suitable for concrete polishing procedures and helps prolong the life of polished finishes.</p> <p><b>Concrete Hardner Lithium Lt 5 (Ready to use)</b></p> <p><b>Concrete Hardner Lithium Lt 25 (Ready to use)</b></p> <p><b>Concrete Hardner Lithium HQ Lt 25 (High concentration to be diluted 1:3)</b></p>	<p>€ 90,00</p> <p>€ 375,00</p> <p>€ 790,00</p>								
	<p><b>CONCRETE KS SHIELD</b> Penetrating stain and water repellent for polished concrete. Special formulation which makes the surface water repellent while leaving its aesthetic characteristics and substrate transpirability unchanged. Invisible protection and adds in durability and resistance against wear due to weather and many other agents. It prevents fluorescence and mold build-ups. It does not create a film, but penetrates into the concrete covering the inner surface of each pore.</p> <p><b>Concrete KS Shield Lt 5</b></p> <p><b>Concrete KS Shield BOX 4x5 Lt</b></p>	<p>€ 85,50</p> <p>€ 326,00</p>								
	<p><b>CONCRETE GUARD LITHIUM</b> High gloss, oil-repellent treatment, stain and wear resistant concrete sealer. Once applied and burnished it makes a very hard film for maximum protection. It can be applied directly on the floor by using microfiber cloth. After application we suggest to polishing the surface with high speed machine. Suitable for industrial areas with heavy traffic.</p> <p><b>Concrete Guard Lithium Plus Lt 5</b></p> <p><b>Concrete Guard Lithium Plus Lt 25</b></p> <p><b>Concrete Guard Lithium HQ (High concentration) Lt 5</b></p> <p><b>Concrete Guard Lithium HQ (High concentration) Lt 25</b></p>	<p>€ 159,00</p> <p>€ 735,00</p> <p>€ 238,00</p> <p>€ 1090,00</p>								
	<p><b>CONCRETE GLOSS PRIMER (Lithium Based)</b> Concrete Gloss Primer is the perfect bonding base before the application of Concrete Gloss Finish. The combination of the 2 products protects the surface against wear due to heavy equipment and traffic, stain and UV degradation. Recommended level of grinding/polishing before application is 200-400 grit or higher. The floor must be cleaned and dry.</p> <p><b>CONCRETE GLOSS FINISH (Lithium Based)</b> Concrete sealer, oil repellent treatment, once applied and burnished it makes a very hard film for maximum protection against wear due to heavy equipment and traffic. Extremely durable, perfect protection against stain formation and suitable for extreme requirements in food service and retail stores.</p> <table border="1" data-bbox="488 1738 740 1839"> <thead> <tr> <th>*Mixing</th> <th>Ratio</th> </tr> </thead> <tbody> <tr> <td>Soft Concrete</td> <td>1:16</td> </tr> <tr> <td>Medium Concrete</td> <td>1:18</td> </tr> <tr> <td>Hard Concrete</td> <td>1:24</td> </tr> </tbody> </table> <p><b>Concrete Gloss Primer Lt 1 Concentrated Product (to be diluted*)</b></p> <p><b>Concrete Gloss Finish Lt 1 Concentrated Product (to be diluted*)</b></p>	*Mixing	Ratio	Soft Concrete	1:16	Medium Concrete	1:18	Hard Concrete	1:24	<p>€ 155,00</p> <p>€ 139,00</p>
*Mixing	Ratio									
Soft Concrete	1:16									
Medium Concrete	1:18									
Hard Concrete	1:24									
	<p><b>CONCRETE OWR STRONG H2O</b> Water-based impregnating agent, ideal to protect all concrete surfaces. Excellent repellency to oily substances and water. Anti stain product, non-flammable, easy to use, doesn't make films and lets the surfaces breathe. Increase the life of the floor and keep the aesthetic of the surface. Reduces the damage caused by freezing / thawing and salt efflorescence. Can be applied on the floor after last grinding step. Apply on a dry and clean surface. Spray the product on the floor and spread with a micro fiber cloth. Wait 24 hours before applying the final sealer (Concrete Guard Lithium).</p> <p><b>Concrete OWR Strong H2O Lt 5</b></p> <p><b>Concrete OWR Strong H2O Lt 20</b></p>	<p>€ 195,00</p> <p>€ 925,00</p>								

# Products FOR CONCRETE

	DESCRIPTION	PRICE								
	<p><b>CONCRETE OIL CLEANER</b> Biphasic alkaline detergent. Industrial detergent specifically designed for rapid and deep cleaning of industrial surfaces in sludge concrete and heavy dirt. Super-concentrated detergent suitable to solubilize and to eliminate quickly various types of dirt. High penetrating, emollient and emulsifying power. Concrete Oil Cleaner also removes the most tenacious dirt, guaranteeing deeper cleaning. Concrete Oil Cleaner can be used for extraordinary cleaning on various industrial surfaces such as cement and synthetic coatings. <b>MIXING RATIO from 1:5 to 1:8</b></p>									
	<b>Concrete Oil Cleaner Lt 12</b>	€ 260,00								
	<p><b>CONCRETE FILLER</b> For grouting and filling up small holes and micro cracks of the concrete floor. Can be applied directly on the floor during the grinding operation step grit 120. Concrete Filler fills the surface with the same color. Compatible with densifiers, sealers and Color Dye.</p>									
	<b>Concrete Filler (Sodium / Potassium Based) Lt 25</b> - Concentrated Product (to be diluted 1:9 with water)	€ 480,00								
	<p><b>CONCRETE FILLER PLUS (Lithium Based)</b> <b>Concrete Filler Plus Lt 1</b> - Concentrated Product (to be diluted*)</p> <table border="1"> <thead> <tr> <th>*Mixing</th> <th>Ratio</th> </tr> </thead> <tbody> <tr> <td>Soft Concrete</td> <td>1:16</td> </tr> <tr> <td>Medium Concrete</td> <td>1:18</td> </tr> <tr> <td>Hard Concrete</td> <td>1:24</td> </tr> </tbody> </table>	*Mixing	Ratio	Soft Concrete	1:16	Medium Concrete	1:18	Hard Concrete	1:24	€ 110,00
*Mixing	Ratio									
Soft Concrete	1:16									
Medium Concrete	1:18									
Hard Concrete	1:24									
	<p><b>CONCRETE GROUT</b> Specific product cement based born to fill and repairing micro cracks and micro holes on concrete floors. Dry in 24 hours.</p>									
	<b>CRACKS From 0 to 5 mm (Kg 5)</b>	€ 109,00								
	<b>CRACKS From 5 to 25 mm (Kg 25)</b>	€ 149,00								
	<p><b>CONCRETE GROUT A+B</b> Bicomponent resin ideal to seal and grouting large and micro holes and cracks on concrete floors. It can be mixed with grinding dust up to 50% in order to obtain the desired color and consistency. Dry in 20/25 minutes.</p>									
	<b>Concrete Grout A+B Kg 5 (Hardner agent included)</b>	€ 165,00								
	<p><b>KS SLURRY DRYER</b> <i>Solidifier for concrete and natural stones sludges</i> Super absorbent polymer designed by Klinsystem to absorb and retain fluids in order to reduce the volume and simplify transport. It is a soluble polymer with a white granular consistency in its dry form. When it comes in contact with the sludge, it forms a gel with excellent mechanical stability that holds these liquids, even under stress, since absorption is based on a physical-chemical process. The performance of superabsorbent polymers is related to the amount of sediment present in the liquids to be absorbed. <b>Use:</b> Spread on slurry and sludges and wait for reaction. <b>Application:</b> Concrete grinding, Concrete and stones saw cutting and drilling, Concrete areas to rinse Natural stone grinding and restoration.</p>									
	<b>KS Slurry Dryer Kg 20</b>	€ 285,00								

## CONCRETE COLOR DYE

Solvent based dyes are the most commonly used products for coloring concrete floors. **Micronized dye particles are catalyzed in acetone, which in turn penetrate into the concrete surface.** Thanks to the very fine pigments, the color penetrates deep into the concrete surface. The more porous the concrete, the deeper the dye color will saturate.

The use of dyes opens a wide spectrum of vivid colors not available with iron oxide or acid stains. It is important to note that these dyes are **not UV stable and should only be used indoors.** The dyes are non-reactive and moisture can affect the longevity of the color, therefore it is highly recommended that moisture tests should be carried out and a topical sealer like Concrete Guard Lithium or Concrete Gloss Finish should be used for additional protection.



### CONCRETE COLOR PLUS (LIQUID)

Concentrated liquid color solution to be dilute in 4 liters of Acetone.

**Application:** all concrete floors. **Colors:** BLACK (5395C), RED (032C), GREEN (369C), BLUE (2925C). The color gradation may vary according to the composition of the concrete, so we recommend to do a preliminary color test.

**Concrete Color Plus 250 ml (quantity for 4 Lt of Acetone)** € 56,50







# Marble POLISHING SYSTEM

## STANDARD PROCESS:

- 1) Start grinding with Metal bond diamond tools **KSM1 Grit 60** and continue until the floor is perfectly levelled. If the floor is very unlevelled or has big lippages, we suggest to start grinding with **KSMO Grit 36**.
- 2) Proceed with Metal tool **KSM2 Grit 120** to eliminate the scratch created with the KSM1.
- 3) Continue with Resin bond diamond tool **Jumpflex Marble 3** or **M-KS3 Grit 6** (for abrasive marble we suggest to use **Pavelux Marble 3 and 4** pag. 60).
- 4) Proceed with Resin tool **Jumpflex Marble 4** or **M-KS4 Grit 120**.
- 5) Continue with Resin tool **Jumpflex Marble 5** or **M-KS5 Grit 220**, **Jumpflex Marble 6** or **M-KS6 Grit 400** and **Jumpflex Marble 7** or **M-KS7 Grit 800**. Usually after step with Resin tool Grit 800, you can polishing the floor using the **POLISHING POWDER** in according to the kind of marble (pag. 60). For hard stones and colored marbles, continue the process with **Jumpflex Marble 8** or **M-KS8 Grit 1800** and **Jumpflex Marble 9** or **M-KS9 Grit 3500**.
- 6) Polishing the floor with the most specific **POLISHING POWDER** in according to the kind of marble (pag. 60).
- 7) Final step, wash the floor with water and **KLINSOAP** to protect the surface and to improve the gloss.

## WAX AND MASTIC FOR MARBLE

Best quality mastic for repairing marble and natural stone floors



	DESCRIPTION	PRICE
	<p><b>WAXDUR CREAM</b> Specific water-based WAX for polishing marble, granite and natural stone. It polishes and water-proofing the floors. Gives an excellent polish effect with a good water and oil repellency.</p> <p><b>Waxdur cream Kg 1</b></p>	€ 36,00
	<p><b>MASTIC SOLID</b> Solid polyester mastic for marble and granite for general repairing, grouting and for vertical application. Available in colours: Straw, white, black, green, red.</p> <p><b>Mastic solid BOX 12x1 Kg</b></p>	€ 118,00
	<p><b>MASTIC LIQUID</b> Liquid polyester mastic for marble and granite for general repairing, grouting and for vertical application. Available in colours: Straw, white, black, green, red.</p> <p><b>Mastic liquid BOX 12x1 Kg</b></p>	€ 118,00
	<p><b>MASTIC TRANSPARENT Solid / Liquid</b> Transparent high quality polyester mastic. Perfect for travertine. Ideal for consolidating stone or repairing fine cracks or fractures. Faster curing time suitable for wide cracks.</p> <p><b>Mastic transparent Solid BOX 12x1 Kg</b></p> <p><b>Mastic transparent Liquid BOX 12x1 Kg</b></p>	<p>€ 215,00</p> <p>€ 205,00</p>
	<p><b>EPOXY RESIN COMPONENT A + B</b> Epoxy resin 2 components (Resin and Hardener 50/50), ideal for consolidating stone or REPAIRING fine cracks or fractures. Faster curing time and more suitable for wide cracks. It can be coloured to match any stone.</p> <p><b>Epoxy resin Component A Kg 1</b></p> <p><b>Epoxy resin Component B Kg 1</b></p>	<p>€ 27,50</p> <p>€ 23,50</p>

# Marble POLISHING SYSTEM

## KS M





### METAL BOND DIAMOND TOOLS

Suitable for marble and natural stone

	DESCRIPTION					PRICE
	<b>KS M0</b>	GRIT 36	Ø 240mm - 9,5"	12 segments	Quick Change	€ 235,00
	<b>KS M1</b>	GRIT 60	Ø 240mm - 9,5"	12 segments	Quick Change	€ 235,00
	<b>KS M2</b>	GRIT 120	Ø 240mm - 9,5"	12 segments	Quick Change	€ 235,00
<small>* KSM Ø 240mm available also 16 segments</small>						
	<b>KS M0</b>	GRIT 36	Ø 200mm - 8"	7 segments	Quick Change	€ 139,00
	<b>KS M1</b>	GRIT 60	Ø 200mm - 8"	7 segments	Quick Change	€ 139,00
	<b>KS M2</b>	GRIT 120	Ø 200mm - 8"	7 segments	Quick Change	€ 139,00
	<b>KS M0</b>	GRIT 36	Ø 140mm - 5,5"	6 segments	Plastic Support	€ 130,50
	<b>KS M1</b>	GRIT 60	Ø 140mm - 5,5"	6 segments	Plastic Support	€ 130,50
	<b>KS M2</b>	GRIT 120	Ø 140mm - 5,5"	6 segments	Plastic Support	€ 130,50
	<b>KS M0</b>	GRIT 36	Ø 100mm - 4"	6 segments	Plastic Support	€ 130,50
	<b>KS M1</b>	GRIT 60	Ø 100mm - 4"	6 segments	Plastic Support	€ 127,00
	<b>KS M2</b>	GRIT 120	Ø 100mm - 4"	6 segments	Plastic Support	€ 127,00



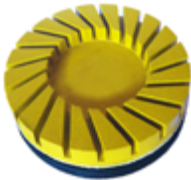

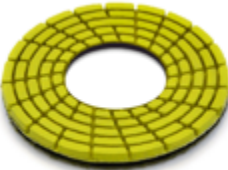

## RESIN BOND DIAMOND TOOLS

Suitable for marble and natural stone

	DESCRIPTION					PRICE
	<b>JUMPFLEX MARBLE 3</b>	GRIT 60	Ø 75mm - 3"	Velcro connection		€ 24,00
	<b>JUMPFLEX MARBLE 4</b>	GRIT 120	Ø 75mm - 3"	Velcro connection		€ 24,00
	<b>JUMPFLEX MARBLE 5</b>	GRIT 220	Ø 75mm - 3"	Velcro connection		€ 24,00
	<b>JUMPFLEX MARBLE 6</b>	GRIT 400	Ø 75mm - 3"	Velcro connection		€ 24,00
	<b>JUMPFLEX MARBLE 7</b>	GRIT 800	Ø 75mm - 3"	Velcro connection		€ 24,00
	<b>JUMPFLEX MARBLE 8</b>	GRIT 1800	Ø 75mm - 3"	Velcro connection		€ 24,00
	<b>JUMPFLEX MARBLE 3</b>	GRIT 60	Ø 100mm - 4"	Velcro connection		€ 31,00
	<b>JUMPFLEX MARBLE 4</b>	GRIT 120	Ø 100mm - 4"	Velcro connection		€ 31,00
	<b>JUMPFLEX MARBLE 5</b>	GRIT 220	Ø 100mm - 4"	Velcro connection		€ 31,00
	<b>JUMPFLEX MARBLE 6</b>	GRIT 400	Ø 100mm - 4"	Velcro connection		€ 31,00
	<b>JUMPFLEX MARBLE 7</b>	GRIT 800	Ø 100mm - 4"	Velcro connection		€ 31,00
	<b>JUMPFLEX MARBLE 8</b>	GRIT 1800	Ø 100mm - 4"	Velcro connection		€ 31,00
	<b>M-KS 3</b>	GRIT 60	Ø 100mm - 4"	Plastic support connection		€ 45,00
	<b>M-KS 4</b>	GRIT 120	Ø 100mm - 4"	Plastic support connection		€ 45,00
	<b>M-KS 5</b>	GRIT 220	Ø 100mm - 4"	Plastic support connection		€ 45,00
	<b>M-KS 6</b>	GRIT 400	Ø 100mm - 4"	Plastic support connection		€ 45,00
	<b>M-KS 7</b>	GRIT 800	Ø 100mm - 4"	Plastic support connection		€ 45,00
	<b>M-KS 8</b>	GRIT 1800	Ø 100mm - 4"	Plastic support connection		€ 45,00
	<b>M-KS 3</b>	GRIT 60	Ø 140mm - 5,5"	Velcro connection		€ 47,00
	<b>M-KS 4</b>	GRIT 120	Ø 140mm - 5,5"	Velcro connection		€ 47,00
	<b>M-KS 5</b>	GRIT 220	Ø 140mm - 5,5"	Velcro connection		€ 47,00
	<b>M-KS 6</b>	GRIT 400	Ø 140mm - 5,5"	Velcro connection		€ 47,00
	<b>M-KS 7</b>	GRIT 800	Ø 140mm - 5,5"	Velcro connection		€ 47,00
	<b>M-KS 8</b>	GRIT 1800	Ø 140mm - 5,5"	Velcro connection		€ 47,00
	<b>COUGARFLEX MARBLE 3</b>	GRIT 60	Ø 150mm - 6"	Velcro connection		€ 56,00
	<b>COUGARFLEX MARBLE 4</b>	GRIT 120	Ø 150mm - 6"	Velcro connection		€ 56,00
	<b>COUGARFLEX MARBLE 5</b>	GRIT 220	Ø 150mm - 6"	Velcro connection		€ 56,00
	<b>COUGARFLEX MARBLE 6</b>	GRIT 400	Ø 150mm - 6"	Velcro connection		€ 56,00
	<b>COUGARFLEX MARBLE 7</b>	GRIT 800	Ø 150mm - 6"	Velcro connection		€ 56,00
	<b>COUGARFLEX MARBLE 8</b>	GRIT 1800	Ø 150mm - 6"	Velcro connection		€ 56,00

COUGARFLEX MARBLE: Available also 100mm - 4" / 125mm - 5" / 140mm - 5,5"

**Products and chemicals for marble and natural stone**

	DESCRIPTION	PRICE
	<p><b>SHINE GREEN</b> Polishing cream for marbles, artificial marbles and agglomerates. SHINE GREEN increases wear resistance, powerful protection against dust, acid/alkalin, washing, scratches and stain, and excellent self-cleaning properties. Thanks to the thermal force of the crystallization, SHINE GREEN penetrate into the molecular gaps of the floor and then solidify into high-strength, rigid transparent protective layer and form a crystal shield on the surface of the stone.</p>	
	<b>Shine Green Kg 1</b>	€ 36,00
	<p><b>KLINSOAP</b> Shining soap for marble and natural stone. Improves and protects the surface, high quality combination cleaner that simultaneously forms a water insoluble and dirt repellent barrier. Dilute by 0.5 liters every 10 liters of water for daily cleaning, and increase to 1-2 liters per 10 liters for added sealing impregnation effect. Good as final cleaning after polishing procedure of stone, concrete, terrazzo, timber and even vinyl flooring.</p>	
	<b>Klinsoap Box 4x5 Lt</b>	€ 356,00
	<p><b>KRISTAL &amp; LUX</b> Crystallizing liquid specially formulated for vitrifying surfaces of marble and terrazzo. It provides waterproofing and hardness for high traffic resistance. No-slippery, high and long lasting protection and not marks footprints. Mirror Shine effect. Can be used for periodical maintenance of floors already crystallized. <b>Instructions:</b> spray a little quantity of product, spread the product uniformly with a single disc machine fitted with a steel wool pad and work until the product gets completely dry.</p>	
	<b>Kristal &amp; Lux BOX 3x5 Lt</b>	€ 115,00
	<p><b>KS IDROPROOF</b> Water repellent, waterproofing agent/sealer for both indoor and outdoor applications. It's ideal for marble, granite and any other natural stone.</p>	
	<b>KS Idroproof Lt 1</b>	€ 25,50
	<p><b>STONE VARNISH</b> Self-polishing varnish suitable to reach the shine where it is not easy to polish by machine. Gives an excellent polish effect with a good water and oil repellency. It can be used on any natural stones and all marbles.</p>	
	<b>Stone varnish Lt 1</b>	€ 18,15
	<p><b>ANTIQUE EFFECT</b> Waterproofing, wet satin effect for marble and granite floors.</p>	
	<b>Antique effect Lt 1</b>	€ 18,70
	<p><b>BRILL &amp; LUX Solvent based / Water based</b> Crystallizing liquid product for the polishing of marble, terrazzo, limestone, travertine and other types of natural stone surfaces. Self-polishing varnish with a "wet look effect" for marble, granite and natural stones.</p>	
	<b>Brill &amp; Lux Lt 1 (solvent based)</b>	€ 22,95
	<b>Brill &amp; Lux Lt 1 (water based)</b>	€ 16,20

# Products FOR MARBLE



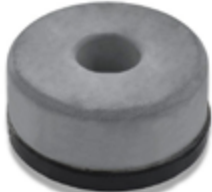
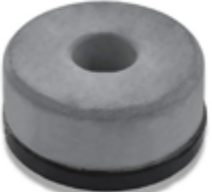

## POLISH POWDER FOR MARBLE Best quality polishing powders made in Italy

	DESCRIPTION	PRICE
	<p><b>POLISH POWDER KSMT</b> High quality polish powder for soft and abrasive marbles like Carrara, limestone etc. KSMT very good quality Polish Powder, excellent solution for daily cleaning of hard surfaces. Fine abrasive, can be use to remove fungus, soap scum build-up and embedded stains in grouting immediately. Suitable for use in big areas, hotels, shopping mall, on all type of natural stone surfaces.</p>	
	<b>Polish powder KSMT 5 Kg</b>	€ 86,00
	<b>Polish powder KSMT 20 Kg</b>	€ 340,00
	<p><b>POLISH POWDER KS92</b> High quality polish powder for standard marbles and limestone. Excellent solution for daily cleaning of natural surfaces. It is fine abrasive adapt to remove fungus, soap scum buildup and embedded stains in grouting immediately. Suitable for use in big areas, hotels, shopping mall, on all type of natural stone surfaces.</p>	
	<b>Polish powder KS92 5 Kg</b>	€ 82,00
	<b>Polish powder KS92 20 Kg</b>	€ 325,00
	<p><b>POLISH POWDER KS85</b> High quality yellow polish powder for marble and terrazzo polishing after grinding steps. Can be used for daily maintenance of polishing marble, terrazzo, porcelain and glass surfaces. It is fine abrasive adapt to remove fungus, soap scum build-up and embedded stains in grouting immediately. Suitable for use in big areas, hotels, shopping mall, on all type of natural stone surfaces.</p>	
	<b>Polish powder KS85 5 Kg</b>	€ 75,00
	<b>Polish powder KS85 20 Kg</b>	€ 305,00
	<p><b>POLISH POWDER KS80</b> High quality yellow polish powder for marble and terrazzo polishing after grinding steps. Can be used for daily maintenance of polishing marble, terrazzo, porcelain and glass surfaces. It is fine abrasive adapt to remove fungus, soap scum build-up and embedded stains in grouting immediately. Suitable for use in big areas, hotels, shopping mall, on all type of natural stone surfaces.</p>	
	<b>Polish powder KS80 5 Kg</b>	€ 75,00
	<b>Polish powder KS80 20 Kg</b>	€ 305,00



## PAVELUX Synthetic tools for removing mastic and grinding abrasive floors where resin tools have not long life

Pavelux for Marble <small>We suggest to use PAVELUX MARBLE 3 and 4 in place of resin tool Grit 60 and 120 (see procedure pag. 57).</small>		
	<p><b>PAVELUX MARBLE 3</b> GRIT 60 Ø 100mm – 4" Velcro connection € 15,50</p>	
	<p><b>PAVELUX MARBLE 4</b> GRIT 120 Ø 100mm – 4" Velcro connection € 15,50</p>	
	<p><b>PAVELUX MARBLE 5</b> GRIT 220 Ø 100mm – 4" Velcro connection € 15,50</p>	
	<p><b>PAVELUX MARBLE 6</b> GRIT 400 Ø 100mm – 4" Velcro connection € 15,50</p>	
	<p><b>PAVELUX MARBLE 7</b> GRIT 800 Ø 100mm – 4" Velcro connection € 15,50</p>	
	<p><b>PAVELUX MARBLE 8</b> GRIT 1800 Ø 100mm – 4" Velcro connection € 15,50</p>	
	<p><b>PAVELUX MARBLE 9</b> GRIT 3500 Ø 100mm – 4" Velcro connection € 15,50</p>	
	Pavelux for Granite and Gres <small>We suggest to use PAVELUX GRANITE 4 and 5 to close all the micro-porosity of the granite. Continue with resin tools Grit 400 (procedure pag. 62).</small>	
		<p><b>PAVELUX GRANITE 3</b> GRIT 60 Ø 100mm – 4" Velcro connection € 15,50</p>
<p><b>PAVELUX GRANITE 4</b> GRIT 120 Ø 100mm – 4" Velcro connection € 15,50</p>		
<p><b>PAVELUX GRANITE 5</b> GRIT 220 Ø 100mm – 4" Velcro connection € 15,50</p>		
<p><b>PAVELUX GRANITE 6</b> GRIT 400 Ø 100mm – 4" Velcro connection € 15,50</p>		
<p><b>PAVELUX GRANITE 7</b> GRIT 800 Ø 100mm – 4" Velcro connection € 15,50</p>		
<p><b>PAVELUX GRANITE 8</b> GRIT 1800 Ø 100mm – 4" Velcro connection € 15,50</p>		
<p><b>PAVELUX GRANITE 9</b> GRIT 3500 Ø 100mm – 4" Velcro connection € 15,50</p>		

\*Available PAVELUX Ø 100mm – 4" with Plastic Support.

DESCRIPTION		PRICE																									
	<p><b>BUSH HAMMER PLATE 3 ROLLERS Ø 240mm - 9,5" - Quick Attack (with greaser)</b> Special tool suitable for many applications: safety anti-slip surfaces on concrete, marble, granite and natural stones</p> <ul style="list-style-type: none"> <li>• Floor preparation, glue, varnish and resin coating removal</li> <li>• To break-down thick coating difficult to remove with normal diamond tools</li> <li>• Bush Hammer allow to get "face-see effect" "on precast panels"</li> <li>• Scarification of any kind of surface</li> <li>• Orange-peel skin effect on concrete and any surface</li> </ul>	€ 1095,00																									
	<p><b>DOUBLE RING GRINDING CUP</b> Metal bond diamond tools grinding cup suitable for hand machines</p> <table border="1"> <tr> <td><b>GC125#36</b></td> <td>Ø 125mm - 5"</td> <td>GRIT 36</td> <td>COARSE</td> <td>€ 105,00</td> </tr> <tr> <td><b>GC125#60</b></td> <td>Ø 125mm - 5"</td> <td>GRIT 60</td> <td>MEDIUM</td> <td>€ 105,00</td> </tr> <tr> <td><b>GC125#120</b></td> <td>Ø 125mm - 5"</td> <td>GRIT 120</td> <td>FINE</td> <td>€ 105,00</td> </tr> </table>	<b>GC125#36</b>	Ø 125mm - 5"	GRIT 36	COARSE	€ 105,00	<b>GC125#60</b>	Ø 125mm - 5"	GRIT 60	MEDIUM	€ 105,00	<b>GC125#120</b>	Ø 125mm - 5"	GRIT 120	FINE	€ 105,00											
<b>GC125#36</b>	Ø 125mm - 5"	GRIT 36	COARSE	€ 105,00																							
<b>GC125#60</b>	Ø 125mm - 5"	GRIT 60	MEDIUM	€ 105,00																							
<b>GC125#120</b>	Ø 125mm - 5"	GRIT 120	FINE	€ 105,00																							
	<p><b>METAL BOND TURBO CUP</b> Designed for grinding and shaping stone and concrete surfaces. Offered in Coarse, Medium, and Fine grit.</p> <table border="1"> <tr> <td><b>TC5-M14-C Turbo Cup, M14</b></td> <td>Ø 125mm - 5"</td> <td>GRIT Coarse</td> <td>€ 134,00</td> </tr> <tr> <td><b>TC5-M14-M Turbo Cup, M14</b></td> <td>Ø 125mm - 5"</td> <td>GRIT Medium</td> <td>€ 134,00</td> </tr> <tr> <td><b>TC5-M14-F Turbo Cup, M14</b></td> <td>Ø 125mm - 5"</td> <td>GRIT Fine</td> <td>€ 134,00</td> </tr> </table>	<b>TC5-M14-C Turbo Cup, M14</b>	Ø 125mm - 5"	GRIT Coarse	€ 134,00	<b>TC5-M14-M Turbo Cup, M14</b>	Ø 125mm - 5"	GRIT Medium	€ 134,00	<b>TC5-M14-F Turbo Cup, M14</b>	Ø 125mm - 5"	GRIT Fine	€ 134,00														
<b>TC5-M14-C Turbo Cup, M14</b>	Ø 125mm - 5"	GRIT Coarse	€ 134,00																								
<b>TC5-M14-M Turbo Cup, M14</b>	Ø 125mm - 5"	GRIT Medium	€ 134,00																								
<b>TC5-M14-F Turbo Cup, M14</b>	Ø 125mm - 5"	GRIT Fine	€ 134,00																								
	<p><b>EDGE MASTER 5-STEP GRINDING SYSTEM</b> High performing ceramic bond to refine and blend your edge work faster and more efficiently for concrete floors. Step 1 Grit Extra Coarse removes deep scratches or any hard topical materials on the edges. In most cases, start with Step 2 Grit Coarse. Wet and dry use.</p> <table border="1"> <tr> <td><b>EM-5-XC Edge Master Ceramic Turbo Cup, M14</b></td> <td>Ø 125mm - 5"</td> <td>GRIT Extra Coarse</td> <td>STEP 1</td> <td>€ 122,00</td> </tr> <tr> <td><b>EM-5-C Edge Master Ceramic Turbo Cup, M14</b></td> <td>Ø 125mm - 5"</td> <td>GRIT Coarse</td> <td>STEP 2</td> <td>€ 122,00</td> </tr> <tr> <td><b>EM-5-M Edge Master Ceramic Turbo Cup, M14</b></td> <td>Ø 125mm - 5"</td> <td>GRIT Medium</td> <td>STEP 3</td> <td>€ 122,00</td> </tr> <tr> <td><b>EM-5-F Edge Master Ceramic Turbo Cup, M14</b></td> <td>Ø 125mm - 5"</td> <td>GRIT Fine</td> <td>STEP 4</td> <td>€ 122,00</td> </tr> <tr> <td><b>EM-5-XF Edge Master Ceramic Turbo Cup, M14</b></td> <td>Ø 125mm - 5"</td> <td>GRIT Extra Fine</td> <td>STEP 5</td> <td>€ 122,00</td> </tr> </table>	<b>EM-5-XC Edge Master Ceramic Turbo Cup, M14</b>	Ø 125mm - 5"	GRIT Extra Coarse	STEP 1	€ 122,00	<b>EM-5-C Edge Master Ceramic Turbo Cup, M14</b>	Ø 125mm - 5"	GRIT Coarse	STEP 2	€ 122,00	<b>EM-5-M Edge Master Ceramic Turbo Cup, M14</b>	Ø 125mm - 5"	GRIT Medium	STEP 3	€ 122,00	<b>EM-5-F Edge Master Ceramic Turbo Cup, M14</b>	Ø 125mm - 5"	GRIT Fine	STEP 4	€ 122,00	<b>EM-5-XF Edge Master Ceramic Turbo Cup, M14</b>	Ø 125mm - 5"	GRIT Extra Fine	STEP 5	€ 122,00	
<b>EM-5-XC Edge Master Ceramic Turbo Cup, M14</b>	Ø 125mm - 5"	GRIT Extra Coarse	STEP 1	€ 122,00																							
<b>EM-5-C Edge Master Ceramic Turbo Cup, M14</b>	Ø 125mm - 5"	GRIT Coarse	STEP 2	€ 122,00																							
<b>EM-5-M Edge Master Ceramic Turbo Cup, M14</b>	Ø 125mm - 5"	GRIT Medium	STEP 3	€ 122,00																							
<b>EM-5-F Edge Master Ceramic Turbo Cup, M14</b>	Ø 125mm - 5"	GRIT Fine	STEP 4	€ 122,00																							
<b>EM-5-XF Edge Master Ceramic Turbo Cup, M14</b>	Ø 125mm - 5"	GRIT Extra Fine	STEP 5	€ 122,00																							

## FLOOR PADS Floor pads for polishing, buffing and daily cleaning

DESCRIPTION		PRICE
 <p><b>PADLUX NATURAL FLOOR PAD</b> Formulated with natural fibers for polishing marble, granite, concrete and natural stone. Can be used specially with Polishing powder and also with High-speed machine. Minimum order is 1 BOX composed by 5 pieces.</p>  <ul style="list-style-type: none"> <li>• <b>WHITE FLOOR PAD</b> For polishing floors.</li> <li>• <b>RED FLOOR PAD</b> For spray cleaning.</li> <li>• <b>BLACK FLOOR PAD</b> For wet stripping hard floor.</li> <li>• <b>GREEN FLOOR PAD</b> For wet stripping on linoleum, rubber.</li> </ul> <p>Minimum order is 1 BOX composed by 5 pieces.</p>	<p><b>PADLUX NATURAL FLOOR PAD</b> Ø 100mm - 4" € 5,00</p> <p><b>PADLUX NATURAL FLOOR PAD</b> Ø 150mm - 6" € 5,85</p> <p><b>PADLUX NATURAL FLOOR PAD</b> Ø 240mm - 9,5" € 7,75</p> <p><b>PADLUX NATURAL FLOOR PAD</b> Ø 280mm - 11" € 8,80</p> <p><b>PADLUX NATURAL FLOOR PAD</b> Ø 330mm - 13" € 11,15</p> <p><b>PADLUX NATURAL FLOOR PAD</b> Ø 430mm - 17" € 12,85</p> <p><b>PADLUX NATURAL FLOOR PAD</b> Ø 540mm - 21" € 18,70</p> <p><b>PADLUX NATURAL FLOOR PAD</b> Ø 660mm - 26" € 31,50</p> <p><b>PADLUX NATURAL FLOOR PAD</b> Ø 710mm - 28" € 35,00</p>	
	<b>FLOOR PADS</b> Ø 100mm - 4" € 4,60	
	<b>FLOOR PADS</b> Ø 150mm - 6" € 5,50	
	<b>FLOOR PADS</b> Ø 240mm - 9,5" € 7,30	
	<b>FLOOR PADS</b> Ø 280mm - 11" € 7,75	
	<b>FLOOR PADS</b> Ø 330mm - 13" € 8,20	
	<b>FLOOR PADS</b> Ø 430mm - 17" € 11,20	
	<b>FLOOR PADS</b> Ø 540mm - 21" € 17,30	
	<b>FLOOR PADS</b> Ø 660mm - 26" € 31,00	
	<b>FLOOR PADS</b> Ø 710mm - 28" € 33,50	

# Granite POLISHING SYSTEM



**STANDARD PROCESS:**

- 1) Start grinding with Metal bond **KSG1 Grit 36** and continue until the floor is perfectly levelled.
- 2) Proceed with Metal tool **KSG2 Grit 60** to eliminate the scratch created from the KSG1.
- 3) Continue with Metal tools **KSG3 Grit 120** until the floor is smooth and no scratches.
- 4) Continue with Resin bond diamond tool **Jumpflex Granite 3** or **G-KS3 Grit 60**, **Jumpflex Granite 4** or **G-KS4 Grit 120**, (we suggest to use **PAVELUX GRANITE 4 and 5** to close all the micro-porosity of the granite)
- 5) Continue with **Jumpflex Granite 5** or **G-KS5 Grit 220**, **Jumpflex Granite 6** or **G-KS6 Grit 400**, **Jumpflex Granite 7** or **G-KS7 Grit 800**, **Jumpflex Granite 8** or **G-KS8 Grit 1800** and **Jumpflex Granite 9** or **G-KS9 Grit 3500**.
- 6) After step 9 you can polishing the floor using **POLISH POWDER GRANITE** for standard granite or **POLISH POWDER GRANITE CLEAR** for clear granite floor.
- 7) Use **SHINE BLU** crystallizing cream for final polishing and crystallization to protect and improve the gloss and the colour of the surfaces.





## POLISH POWDERS AND CHEMICALS

Best quality polishing powders and product made in Italy suitable for granite and gres



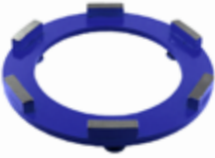

	DESCRIPTION	PRICE
	<p><b>SHINE BLU</b> Crystallizing cream for granite and gres. Increases wear resistance, powerful protection against dust, acid/alkalin, washing, scratches and stain, and excellent self-cleaning properties. Thanks to the thermal force of the crystallization, SHINE BLU penetrate into the molecular gaps of the floor and then solidify into high-strength, rigid transparent protective layer and form a crystal shield on the surface of the stone. SHINE BLU is a polishing cream specifically made for polishing granite and gres.</p> <p><b>Shine Blu Kg 1</b></p>	<p>€ 38,00</p>
	<p><b>POLISH POWDER GRANITE</b> Excellent POLISH POWDER for daily cleaning and maintenance of granite surfaces. It is fine abrasive adapt to remove fungus, soap scum build-up and embedded stains in grouting immediately. Suitable for use in big areas, hotels, shopping mall, on all type of dark granite surfaces.</p> <p><b>Polish powder Granite Kg 5</b></p>	<p>€ 195,00</p>
	<p><b>POLISH POWDER GRANITE CLEAR</b> Excellent POLISH POWDER for daily cleaning and maintenance of clear granite surfaces. It is fine abrasive adapt to remove fungus, soap scum build-up and embedded stains in grouting immediately. Suitable for use in big areas, hotels, shopping mall, on all type of clear granite surfaces.</p> <p><b>Polish powder Granite clear Kg 5</b></p>	<p>€ 195,00</p>

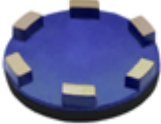
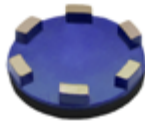
**KS G METAL BOND DIAMOND TOOLS**

Suitable for granite and gres

	DESCRIPTION					PRICE
	<b>KS G1</b>	GRIT 60	Ø 240mm - 9,5"	<b>6 segments</b>	Quick Change	€ 162,00
	<b>KSG2</b>	GRIT 120	Ø 240mm - 9,5"	<b>6 segments</b>	Quick Change	€ 152,50
	<b>KS G3</b>	GRIT 220	Ø 240mm - 9,5"	<b>6 segments</b>	Quick Change	€ 152,50
<i>* KSM Ø 240mm available also 12 segments</i>						
	<b>KS G1</b>	GRIT 60	Ø 200mm - 8"	<b>6 segments</b>	Quick Change	€ 162,00
	<b>KS G2</b>	GRIT 120	Ø 200mm - 8"	<b>6 segments</b>	Quick Change	€ 152,50
	<b>KS G3</b>	GRIT 220	Ø 200mm - 8"	<b>6 segments</b>	Quick Change	€ 152,50
	<b>KS G1</b>	GRIT 60	Ø 140mm - 5,5"	<b>6 segments</b>	Plastic Support	€ 143,00
	<b>KS G2</b>	GRIT 120	Ø 140mm - 5,5"	<b>6 segments</b>	Plastic Support	€ 143,00
	<b>KS G3</b>	GRIT 220	Ø 140mm - 5,5"	<b>6 segments</b>	Plastic Support	€ 143,00
	<b>KS G1</b>	GRIT 60	Ø 100mm - 4"	<b>6 segments</b>	Plastic Support	€ 139,00
	<b>KS G2</b>	GRIT 120	Ø 100mm - 4"	<b>6 segments</b>	Plastic Support	€ 139,00
	<b>KS G3</b>	GRIT 220	Ø 100mm - 4"	<b>6 segments</b>	Plastic Support	€ 139,00

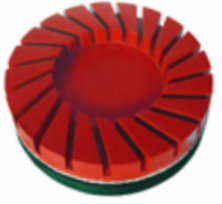
**RESIN BOND DIAMOND TOOLS** Suitable for granite and gres

	DESCRIPTION					PRICE
	<b>JUMPFLEX GRANITE 3</b>	GRIT 60	Ø 75mm - 3"	Velcro connection		€ 24,00
	<b>JUMPFLEX GRANITE 4</b>	GRIT 120	Ø 75mm - 3"	Velcro connection		€ 24,00
	<b>JUMPFLEX GRANITE 5</b>	GRIT 220	Ø 75mm - 3"	Velcro connection		€ 24,00
	<b>JUMPFLEX GRANITE 6</b>	GRIT 400	Ø 75mm - 3"	Velcro connection		€ 24,00
	<b>JUMPFLEX GRANITE 7</b>	GRIT 800	Ø 75mm - 3"	Velcro connection		€ 24,00
	<b>JUMPFLEX GRANITE 8</b>	GRIT 1800	Ø 75mm - 3"	Velcro connection		€ 24,00
	<b>JUMPFLEX GRANITE 9</b>	GRIT 3500	Ø 75mm - 3"	Velcro connection		€ 24,00
	<b>JUMPFLEX GRANITE 3</b>	GRIT 60	Ø 100mm - 4"	Velcro connection		€ 31,00
	<b>JUMPFLEX GRANITE 4</b>	GRIT 120	Ø 100mm - 4"	Velcro connection		€ 31,00
	<b>JUMPFLEX GRANITE 5</b>	GRIT 220	Ø 100mm - 4"	Velcro connection		€ 31,00
	<b>JUMPFLEX GRANITE 6</b>	GRIT 400	Ø 100mm - 4"	Velcro connection		€ 31,00
	<b>JUMPFLEX GRANITE 7</b>	GRIT 800	Ø 100mm - 4"	Velcro connection		€ 31,00
	<b>JUMPFLEX GRANITE 8</b>	GRIT 1800	Ø 100mm - 4"	Velcro connection		€ 31,00
	<b>JUMPFLEX GRANITE 9</b>	GRIT 3500	Ø 100mm - 4"	Velcro connection		€ 31,00
	<b>G-KS 3</b>	GRIT 60	Ø 100mm - 4"	Plastic support connection		€ 45,00
	<b>G-KS 4</b>	GRIT 120	Ø 100mm - 4"	Plastic support connection		€ 45,00
	<b>G-KS 5</b>	GRIT 220	Ø 100mm - 4"	Plastic support connection		€ 45,00
	<b>G-KS 6</b>	GRIT 400	Ø 100mm - 4"	Plastic support connection		€ 45,00
	<b>G-KS 7</b>	GRIT 800	Ø 100mm - 4"	Plastic support connection		€ 45,00
	<b>G-KS 8</b>	GRIT 1800	Ø 100mm - 4"	Plastic support connection		€ 45,00
	<b>G-KS 9</b>	GRIT 3500	Ø 100mm - 4"	Plastic support connection		€ 45,00
	<b>G-KS 3</b>	GRIT 60	Ø 140mm - 5,5"	Velcro connection		€ 47,00
	<b>G-KS 4</b>	GRIT 120	Ø 140mm - 5,5"	Velcro connection		€ 47,00
	<b>G-KS 5</b>	GRIT 220	Ø 140mm - 5,5"	Velcro connection		€ 47,00
	<b>G-KS 6</b>	GRIT 400	Ø 140mm - 5,5"	Velcro connection		€ 47,00
	<b>G-KS 7</b>	GRIT 800	Ø 140mm - 5,5"	Velcro connection		€ 47,00
	<b>G-KS 8</b>	GRIT 1800	Ø 140mm - 5,5"	Velcro connection		€ 47,00
	<b>G-KS 9</b>	GRIT 3500	Ø 140mm - 5,5"	Velcro connection		€ 47,00
	<b>COUGARFLEX GRANITE 3</b>	GRIT 60	Ø 150mm - 6"	Velcro connection		€ 56,00
	<b>COUGARFLEX GRANITE 4</b>	GRIT 120	Ø 150mm - 6"	Velcro connection		€ 56,00
	<b>COUGARFLEX GRANITE 5</b>	GRIT 220	Ø 150mm - 6"	Velcro connection		€ 56,00
	<b>COUGARFLEX GRANITE 6</b>	GRIT 400	Ø 150mm - 6"	Velcro connection		€ 56,00
	<b>COUGARFLEX GRANITE 7</b>	GRIT 800	Ø 150mm - 6"	Velcro connection		€ 56,00
	<b>COUGARFLEX GRANITE 8</b>	GRIT 1800	Ø 150mm - 6"	Velcro connection		€ 56,00
	<b>COUGARFLEX GRANITE 9</b>	GRIT 3500	Ø 150mm - 6"	Velcro connection		€ 56,00

COUGARFLEX GRANITE: Available also 100mm - 4" / 125mm - 5" / 140mm - 5,5"

# Terrazzo POLISHING SYSTEM

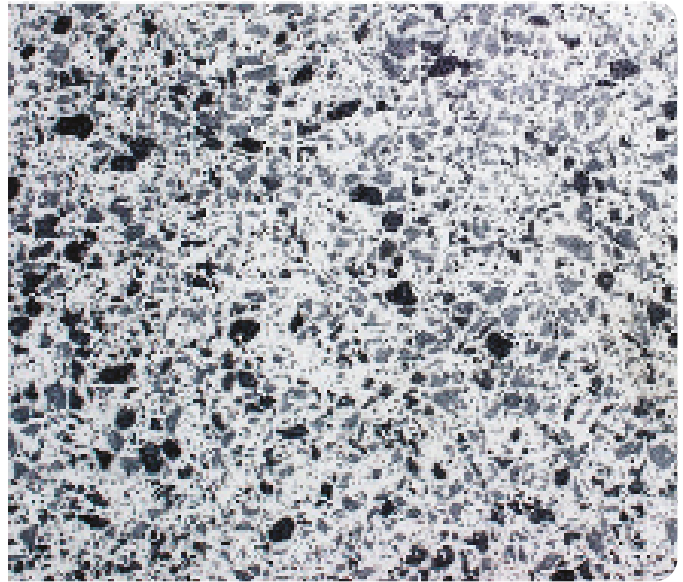
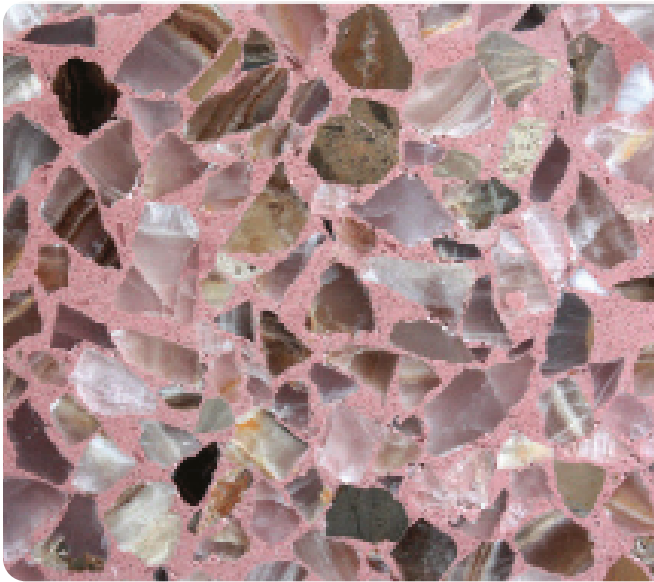

## STANDARD PROCESS:

- 1) Start grinding with Metal bond diamond tools **KST1 Grit 60** and continue until the floor is perfectly levelled. If the floor is very unlevelled or has big lippages, we suggest to start grinding with **KSTO Grit 36**.
- 2) Proceed with Metal tool **KST2 Grit 120** to eliminate the scratch created with the KST1.
- 3) Continue with Resin bond diamond tool **Jumpflex Terrazzo 3** or **T-KS3 Grit 60**.
- 4) Proceed with Resin tool **Jumpflex Terrazzo 4** or **T-KS4 Grit 120** (we suggest to use Concrete Hardner to increase the hardness of the floor).
- 5) Continue with Resin tool **Jumpflex Terrazzo 5** or **T-KS5 Grit 220**, **Jumpflex Terrazzo 6** or **T-KS6 Grit 400**, **Jumpflex Terrazzo 7** or **T-KS7 Grit 800** and **Jumpflex Terrazzo 8** or **T-KS8 Grit 1800**.
- 6) Polish the floor with **POLISH POWDER MOSAIC**. Using **PADLUX Natural Floor Pad**.
- 7) Final step, wash the floor with water and **KLINSOAP** to protect the surface and to improve the gloss.



## POLISH POWDERS AND CHEMICALS





Best quality polishing powders and product made in Italy suitable for terrazzo and mosaic

	DESCRIPTION	PRICE
	<p><b>POLISH POWDER MOSAIC</b> Excellent POLISH POWDER for daily cleaning and maintenance of mosaic, terrazzo and palladiana floors. It is fine abrasive adapt to remove fungus, soap scum build-up and embedded stains in grouting immediately. Suitable for use in big areas, hotels, shopping mall, on all type of natural stone surfaces.</p>	<p>€ 155,00</p>
<p><b>Polish powder Mosaic Kg 5</b></p>		
	<p><b>KLINSOAP</b> Improves and protects the surface, high quality combination cleaner that simultaneously forms a water insoluble and dirt repellent barrier. Dilute by 0.5 liters every 10 liters of water for daily cleaning, and increase to 1-2 liters per 10 liters for added sealing impregnation effect. Good as final cleaning after polishing procedure of stone, concrete, terrazzo, timber and even vinyl flooring.</p>	<p>€ 356,00</p>
<p><b>Klinsoap Box 4x5 Lt</b></p>		





# Terrazzo POLISHING SYSTEM

## KS T METAL BOND DIAMOND TOOLS

Suitable for Terrazzo and Mosaic

	DESCRIPTION					PRICE
	<b>KS T0</b>	GRIT 36	Ø 240mm - 9,5"	6 segments	Quick Change	€ 192,00
	<b>KS T1</b>	GRIT 60	Ø 240mm - 9,5"	6 segments	Quick Change	€ 180,00
	<b>KS T2</b>	GRIT 120	Ø 240mm - 9,5"	6 segments	Quick Change	€ 165,00
	* KS T Ø 240mm available also 12 segments					
	<b>KS T0</b>	GRIT 36	Ø 200mm - 8"	6 segments	Quick Change	€ 185,00
	<b>KS T1</b>	GRIT 60	Ø 200mm - 8"	6 segments	Quick Change	€ 175,00
	<b>KS T2</b>	GRIT 120	Ø 200mm - 8"	6 segments	Quick Change	€ 165,00
	<b>KS T0</b>	GRIT 36	Ø 140mm - 5,5"	5 segments	Plastic Support	€ 145,00
	<b>KS T1</b>	GRIT 60	Ø 140mm - 5,5"	5 segments	Plastic Support	€ 135,00
	<b>KS T2</b>	GRIT 120	Ø 140mm - 5,5"	5 segments	Plastic Support	€ 125,00
	<b>KS T0</b>	GRIT 36	Ø 100mm - 4"	5 segments	Plastic Support	€ 139,00
	<b>KS T1</b>	GRIT 60	Ø 100mm - 4"	5 segments	Plastic Support	€ 115,00
	<b>KS T2</b>	GRIT 120	Ø 100mm - 4"	5 segments	Plastic Support	€ 115,00

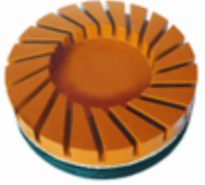
## RESIN BOND DIAMOND TOOLS Suitable for terrazzo and mosaic

	DESCRIPTION					PRICE
	<b>JUMPFLEX TERRAZZO 3</b>	GRIT 60	Ø 75mm - 3"	Velcro connection		€ 19,50
	<b>JUMPFLEX TERRAZZO 4</b>	GRIT 120	Ø 75mm - 3"	Velcro connection		€ 19,50
	<b>JUMPFLEX TERRAZZO 5</b>	GRIT 220	Ø 75mm - 3"	Velcro connection		€ 19,50
	<b>JUMPFLEX TERRAZZO 6</b>	GRIT 400	Ø 75mm - 3"	Velcro connection		€ 19,50
	<b>JUMPFLEX TERRAZZO 7</b>	GRIT 800	Ø 75mm - 3"	Velcro connection		€ 19,50
	<b>JUMPFLEX TERRAZZO 8</b>	GRIT 1800	Ø 75mm - 3"	Velcro connection		€ 19,50
	<b>JUMPFLEX TERRAZZO 3</b>	GRIT 60	Ø 100mm - 4"	Velcro connection		€ 29,50
	<b>JUMPFLEX TERRAZZO 4</b>	GRIT 120	Ø 100mm - 4"	Velcro connection		€ 29,50
	<b>JUMPFLEX TERRAZZO 5</b>	GRIT 220	Ø 100mm - 4"	Velcro connection		€ 29,50
	<b>JUMPFLEX TERRAZZO 6</b>	GRIT 400	Ø 100mm - 4"	Velcro connection		€ 29,50
	<b>JUMPFLEX TERRAZZO 7</b>	GRIT 800	Ø 100mm - 4"	Velcro connection		€ 29,50
	<b>JUMPFLEX TERRAZZO 8</b>	GRIT 1800	Ø 100mm - 4"	Velcro connection		€ 29,50
	<b>T-KS 3</b>	GRIT 60	Ø 100mm - 4"	Plastic support connection		€ 45,00
	<b>T-KS 4</b>	GRIT 120	Ø 100mm - 4"	Plastic support connection		€ 45,00
	<b>T-KS 5</b>	GRIT 220	Ø 100mm - 4"	Plastic support connection		€ 45,00
	<b>T-KS 6</b>	GRIT 400	Ø 100mm - 4"	Plastic support connection		€ 45,00
	<b>T-KS 7</b>	GRIT 800	Ø 100mm - 4"	Plastic support connection		€ 45,00
	<b>T-KS 8</b>	GRIT 1800	Ø 100mm - 4"	Plastic support connection		€ 45,00
	<b>T-KS 3</b>	GRIT 60	Ø 140mm - 5,5"	Velcro connection		€ 47,00
	<b>T-KS 4</b>	GRIT 120	Ø 140mm - 5,5"	Velcro connection		€ 47,00
	<b>T-KS 5</b>	GRIT 220	Ø 140mm - 5,5"	Velcro connection		€ 47,00
	<b>T-KS 6</b>	GRIT 400	Ø 140mm - 5,5"	Velcro connection		€ 47,00
	<b>T-KS 7</b>	GRIT 800	Ø 140mm - 5,5"	Velcro connection		€ 47,00
	<b>T-KS 8</b>	GRIT 1800	Ø 140mm - 5,5"	Velcro connection		€ 47,00
	<b>COUGARFLEX TERRAZZO 3</b>	GRIT 60	Ø 150mm - 6"	Velcro connection		€ 56,00
	<b>COUGARFLEX TERRAZZO 4</b>	GRIT 120	Ø 150mm - 6"	Velcro connection		€ 56,00
	<b>COUGARFLEX TERRAZZO 5</b>	GRIT 220	Ø 150mm - 6"	Velcro connection		€ 56,00
	<b>COUGARFLEX TERRAZZO 6</b>	GRIT 400	Ø 150mm - 6"	Velcro connection		€ 56,00
	<b>COUGARFLEX TERRAZZO 7</b>	GRIT 800	Ø 150mm - 6"	Velcro connection		€ 56,00
	<b>COUGARFLEX TERRAZZO 8</b>	GRIT 1800	Ø 150mm - 6"	Velcro connection		€ 56,00

COUGARFLEX TERRAZZO: Available also 100mm - 4" / 125mm - 5" / 140mm - 5,5"

# Helix DIAMOND FLOOR PADS

## HELIX DIAMOND FLOOR PADS

are an efficient solution for floor restoration and floor maintenance and provides very good results on polished concrete, natural stone, terrazzo, resin floors, etc.



**Marble and Terrazzo polishing system** - Start grinding the floor with HELIX grit 1 and 2 according to the condition of the floor, then proceed with HELIX grit 3 and 4. Use PADLUX floor pad and KS POLISH POWDER with little quantity of water to massage the floor until get the shine.

**Old resin and epoxy coated floor restoration** - (*High speed polishing machine like KP 43 DS DUAL SPEED is recommended*) Start scrubbing the floor with HELIX grit 0 or 1 according to the condition of the floor then proceed with HELIX grit 2 and 3. It is always suggested to work with little quantity of water at the medium speed of 200 rpm for about 60 sec/m<sup>2</sup>. Polish with HELIX grit 4 working with little quantity of water at the higher speed of 400 rpm.

**Matt finish ceramic, klinker and tiles heavy duty cleaning** - (*not for polished tiles*) Start scrubbing the floor with HELIX grit 2 according to the condition of the floor, work at low speed of 160 rpm. Work wet with little quantity of water until old marks and dirty will disappear. Proceed with HELIX grit 4 and little quantity of water at low speed. Polish with HELIX grit 5 working at high speed 400 rpm.

**Linoleum, PVC, Vinyl floor restoration** - (*High speed polishing machine is recommended*) Start scrubbing the floor with HELIX grit 1 or 2 according to the condition of the floor, then proceed with HELIX grit 3. Work with little quantity of water at the medium speed of 200 rpm for about 60 sec/m<sup>2</sup>. Then polish with HELIX grit 4 and little quantity of water at the higher speed of 400 rpm.



DESCRIPTION
<p><b>HELIX 000 Grit 60</b> Aggressive Grit. Suitable to remove deep marks or scratches on marble, concrete, natural stones and terrazzo.</p>
<p><b>HELIX 00 Grit 120</b> Suitable to remove deep marks or scratches on concrete, marble and natural stones.</p>
<p><b>HELIX 0 Grit 220</b> Suitable to remove light marks or light scratches on marble, concrete and natural stones.</p>
<p><b>HELIX 1 Grit 400</b> To use after HELIX 0 for a matt finish. It also remove light scratches on concrete, marble and natural stones.</p>
<p><b>HELIX 2 Grit 800</b> To use after HELIX 1 for a honed finish.</p>
<p><b>HELIX 3 Grit 1800</b> To use after HELIX 2 for a semi gloss finish.</p>
<p><b>HELIX 4 Grit 3500*</b> To use after HELIX 3 for a gloss finish: Grit 4 is ideal for Buffing.</p>

\*Available also  
**HELIX 5 Grit 5000 and  
HELIX 6 Grit 12000 Lux**

DESCRIPTION	SIZE	PRICE
HELIX 000 GRIT 60	240mm - 9,5"	€ 32,00
HELIX 00 GRIT 120	240mm - 9,5"	€ 32,00
HELIX 0 GRIT 220	240mm - 9,5"	€ 32,00
HELIX 1 GRIT 400	240mm - 9,5"	€ 32,00
HELIX 2 GRIT 800	240mm - 9,5"	€ 32,00
HELIX 3 GRIT 1800	240mm - 9,5"	€ 32,00
HELIX 4 GRIT 3500	240mm - 9,5"	€ 32,00
HELIX 000 GRIT 60	330mm - 13"	€ 39,50
HELIX 00 GRIT 120	330mm - 13"	€ 39,50
HELIX 0 GRIT 220	330mm - 13"	€ 39,50
HELIX 1 GRIT 400	330mm - 13"	€ 39,50
HELIX 2 GRIT 800	330mm - 13"	€ 39,50
HELIX 3 GRIT 1800	330mm - 13"	€ 39,50
HELIX 4 GRIT 3500	330mm - 13"	€ 39,50
HELIX 000 GRIT 60	430mm - 17"	€ 60,50
HELIX 00 GRIT 120	430mm - 17"	€ 60,50
HELIX 0 GRIT 220	430mm - 17"	€ 60,50
HELIX 1 GRIT 400	430mm - 17"	€ 60,50
HELIX 2 GRIT 800	430mm - 17"	€ 60,50
HELIX 3 GRIT 1800	430mm - 17"	€ 60,50
HELIX 4 GRIT 3500	430mm - 17"	€ 60,50
HELIX 000 GRIT 60	510mm - 20"	€ 79,00
HELIX 00 GRIT 120	510mm - 20"	€ 79,00
HELIX 0 GRIT 220	510mm - 20"	€ 79,00
HELIX 1 GRIT 400	510mm - 20"	€ 79,00
HELIX 2 GRIT 800	510mm - 20"	€ 79,00
HELIX 3 GRIT 1800	510mm - 20"	€ 79,00
HELIX 4 GRIT 3500	510mm - 20"	€ 79,00

# Helix Plus DIAMOND FLOOR PADS

## REVOLUTIONARY DIAMOND FLOOR PADS SUITABLE TO REMOVE SCRATCHES AND TO RESTORE THE GLOSS OF THE FLOORS.

Transforms your dull, worn floors into clean, glossy and brightly polished floors. Easy to use with standard single disc machine or with Orbital machines to remove scratches, cleaning and polishing the floors.

HELIX PLUS Diamond Floor Pads are an efficient solution for floor grinding, floor restoration and floor maintenance to provide a very good results on Concrete, Marble, Terrazzo, Ceramic, Klinker floors, Natural stone, PVC, Rubber, Vinyl, Epoxy and Wooden floors. HELIX PLUS Diamond Pads are available in several grits from Grit 50 to Grit 3500 and in 2 standard sizes 240mm/9,5" and 430mm/17".

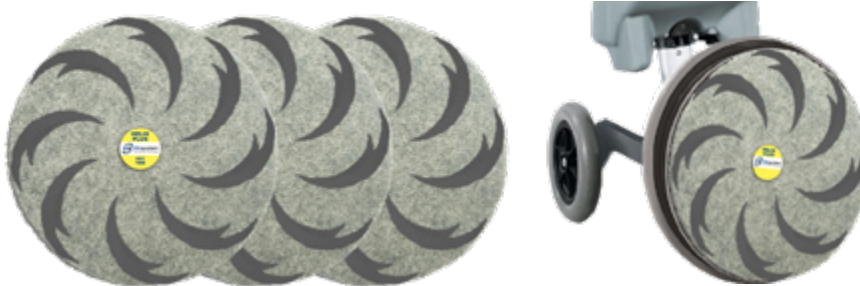

Suitable for  
Single disc machines  
and Orbital machines

### ONLY WATER

HELIX PLUS can be used Wet or Dry. HELIX PLUS requires no chemical or wax. Cleaning and polishing using just water reduces the environmental impact and eliminates additional costs.



Using HELIX PLUS with a **planetary grinding machines** is possible to **polish and re-polish** all kind of floors. Suitable to remove deep scratches and restore acid, wine, cola stained, marble or terrazzo floors.

HELIX PLUS are also suitable for grinding and polishing concrete floors.

Using HELIX PLUS instead of the traditional Floor Pads, allows to restore and maintain the floor always shine during the normal cleaning. For ordinary use, floor maintenance in large areas and also to polish old floors with **Single disc machines, Orbital Machines and auto-scrubbers**, getting results comparable to professional Floor Care Machines.

### DESCRIPTION

#### HELIX PLUS 000 Grit 50

Aggressive Grit. Suitable to remove deep marks or scratches on marble, concrete and natural stones.

#### HELIX PLUS 00 Grit 100

Suitable to remove deep marks or scratches on concrete, marble and natural stones.

#### HELIX PLUS 0 Grit 200

Suitable to remove light marks or light scratches on marble, concrete and natural stones.

#### HELIX PLUS 1 Grit 400

To use after HELIX PLUS 0 for a matt finish. It also remove light scratches on concrete, marble and natural stones.

#### HELIX PLUS 2 Grit 800

To use after HELIX PLUS 1 for a honed finish.

#### HELIX PLUS 3 Grit 1500

To use after HELIX PLUS 2 for a semi gloss finish.

#### HELIX PLUS 4 Grit 3500

To use after HELIX PLUS 3 for a gloss finish: Grit 4 is ideal for Buffing.

DESCRIPTION	SIZE	PRICE
HELIX PLUS 000	GRIT 50	240mm - 9,5" € 32,00
HELIX PLUS 00	GRIT 100	240mm - 9,5" € 32,00
HELIX PLUS 0	GRIT 200	240mm - 9,5" € 32,00
HELIX PLUS 1	GRIT 400	240mm - 9,5" € 32,00
HELIX PLUS 2	GRIT 800	240mm - 9,5" € 32,00
HELIX PLUS 3	GRIT 1500	240mm - 9,5" € 32,00
HELIX PLUS 4	GRIT 3500	240mm - 9,5" € 32,00
HELIX PLUS 000	GRIT 50	430mm - 17" € 58,00
HELIX PLUS 00	GRIT 100	430mm - 17" € 58,00
HELIX PLUS 0	GRIT 200	430mm - 17" € 58,00
HELIX PLUS 1	GRIT 400	430mm - 17" € 58,00
HELIX PLUS 2	GRIT 800	430mm - 17" € 58,00
HELIX PLUS 3	GRIT 1500	430mm - 17" € 58,00
HELIX PLUS 4	GRIT 3500	430mm - 17" € 58,00

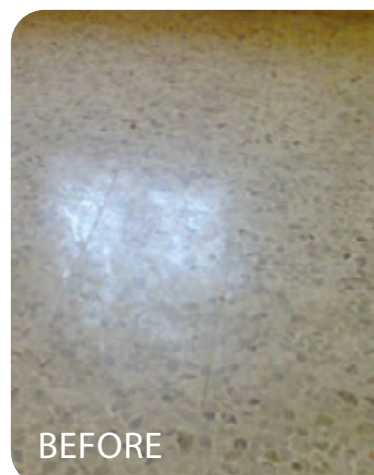

BEFORE



AFTER

# Hypershine STONE / EXTRA

## HYPERSHINE STONE

Transforms your dull, worn floors into clean, glossy and brightly polished floors. Easy to use with standard single disc machine or with Orbital machines to remove scratches, cleaning and polishing the floors. Can be used with single disc machines to re-polish Marble and Terrazzo floors, getting results comparable to professional Floor Care Machines. Suitable to remove deep scratches and restore acid, wine, cola stained-floors.



## HYPERSHINE EXTRA

Diamond Pads is available in several grits, can be used for Marble and Terrazzo, Ceramic and Klinker floors, Natural stone, PVC, Rubber, Vinyl, Epoxy and Wooden floors. Can be used with any type of floor care machines and auto-scrubber. Using HYPERSHINE EXTRA instead of the traditional Floor Pads, allows to restore and maintain the floor always shine during the normal cleaning.

**Just water!** HYPERSHINE EXTRA requires no chemical or wax. Cleaning and polishing using just water reduces the environmental impact and eliminates additional costs. Diamond floor pads designed for ordinary use and floor maintenance in large areas with single disc machines, Orbital Machines and auto-scrubbers. Used with Single disc and Orbital machines they can polish also old floors, ensuring optimal results, HYPERSHINE EXTRA can be used WET or DRY on most of common surfaces such as Marble, terrazzo, ceramic tiles, linoleum, vinyl and natural stone.



### Old wood coating floor restoration

(KP 43 DS DUAL SPEED is recommended)

Start grinding the floor with HYPERSHINE EXTRA grit 1 or 2 according to the condition of the floor then proceed with HYPERSHINE EXTRA grit 3 and 4. Work dry at medium speed of 200 rpm until old marks and imperfection disappear.

### Matt finish ceramic, klinker and glazed tiles heavy duty cleaning

(not for polished tiles).

Start scrubbing the floor with HYPERSHINE EXTRA grit 2 according to the condition of the floor, work at low speed of 160 rpm. Work wet with little quantity of water until old marks and dirty will disappear. Proceed with HYPERSHINE EXTRA grit 4 and little quantity of water at low speed. Polish with HYPERSHINE EXTRA grit 5 working at high speed 400 rpm.

### Old resin and epoxy coated floor restoration

High speed polishing machine like KP 43 DS DUAL SPEED is recommended.

Start scrubbing the floor with HYPERSHINE EXTRA grit 0 or 1 according to the condition of the floor then proceed with HYPERSHINE EXTRA grit 2 and 3. It is always suggested to work with little quantity of water at the medium speed of 200 rpm for about 60 sec/m<sup>2</sup>. Polish with HYPERSHINE EXTRA grit 4 working with little quantity of water at the higher speed of 400 rpm.

### Marble and Terrazzo polishing system

Start grinding the floor with HYPERSHINE EXTRA grit 1 and 2 according to the condition of the floor, then proceed with HYPERSHINE EXTRA grit 3 and 4. Use PADLUX floor pad and KS POLISH POWDER with little quantity of water to massage the floor until get the shine.

### Linoleum, PVC, Vinyl floor restoration

(High speed polishing machine is recommended)

Start scrubbing the floor with HYPERSHINE EXTRA grit 1 or 2 according to the condition of the floor, then proceed with HYPERSHINE EXTRA grit 3. Work with little quantity of water at the medium speed of 200 rpm for about 60 sec/m<sup>2</sup>. Then polish with HYPERSHINE EXTRA grit 4 and little quantity of water at the higher speed of 400 rpm.



# Hypershine STONE / EXTRA

## HYPERSHINE STONE

**Revolutionary Diamond Floor Pads suitable to remove scratches and restore the gloss on marble and terrazzo floors.**

HYPERSHINE STONE can be used with single disc machines or with Orbital machines to re-polishing Marble and Terrazzo floors. Suitable to remove deep scratches and to restore scratched and stained-floors.

Start grinding the floor with HYPERSHINE STONE 00 or 0 in according to the condition of the floor, then proceed with HYPERSHINE STONE 1 and 2 (work with little quantity of water). Polish the floor with Polish Powder and Padluxe Floor Pad.



DESCRIPTION	SIZE	PRICE
HYPERSHINE STONE 000 GRIT 60	330mm - 13"	€ 52,00
HYPERSHINE STONE 00 GRIT 120	330mm - 13"	€ 52,00
HYPERSHINE STONE 0 GRIT 220	330mm - 13"	€ 52,00
HYPERSHINE STONE 1 GRIT 400	330mm - 13"	€ 52,00
HYPERSHINE STONE 2 GRIT 800	330mm - 13"	€ 52,00
HYPERSHINE STONE 3 GRIT 1800	330mm - 13"	€ 52,00
HYPERSHINE STONE 4 GRIT BUFF	330mm - 13"	€ 52,00
HYPERSHINE STONE 000 GRIT 60	430mm - 17"	€ 60,00
HYPERSHINE STONE 00 GRIT 120	430mm - 17"	€ 60,00
HYPERSHINE STONE 0 GRIT 220	430mm - 17"	€ 60,00
HYPERSHINE STONE 1 GRIT 400	430mm - 17"	€ 60,00
HYPERSHINE STONE 2 GRIT 800	430mm - 17"	€ 60,00
HYPERSHINE STONE 3 GRIT 1800	430mm - 17"	€ 60,00
HYPERSHINE STONE 4 GRIT BUFF	430mm - 17"	€ 60,00
HYPERSHINE STONE 000 GRIT 60	510mm - 20"	€ 75,00
HYPERSHINE STONE 00 GRIT 120	510mm - 20"	€ 75,00
HYPERSHINE STONE 0 GRIT 220	510mm - 20"	€ 75,00
HYPERSHINE STONE 1 GRIT 400	510mm - 20"	€ 75,00
HYPERSHINE STONE 2 GRIT 800	510mm - 20"	€ 75,00
HYPERSHINE STONE 3 GRIT 1800	510mm - 20"	€ 75,00
HYPERSHINE STONE 4 GRIT BUFF	510mm - 20"	€ 75,00

## HYPERSHINE EXTRA

**Transforms your dull floor into clean and polished floor. Easy to use with standard single disc machine or with Orbital machines to remove scratches, cleaning and polishing the floors.**

HYPERSHINE EXTRA is available in 7 different grits, can be used for Concrete, Marble, Terrazzo, Ceramic, Klinker, Natural stone, PVC, Rubber, Vinyl, Epoxy and Wooden floors. HYPERSHINE EXTRA can be used Wet or Dry with any type of floor care machines and auto-scrubber. Using HYPERSHINE EXTRA instead of the traditional Floor Pads, allows to restore and keep the floor shine during the normal cleaning. HYPERSHINE EXTRA requires no chemical or wax. Using just water reduces the environment and eliminates additional costs.

### DESCRIPTION

#### 000 Grit 60

Aggressive Grit. Suitable to remove deep marks or scratches on marble, concrete and natural stones.

#### 00 Grit 120

Suitable to remove deep marks or scratches on concrete, marble and natural stones.

#### 0 Grit 220

Suitable to remove light marks or light scratches on marble, concrete and natural stones.

#### 1 Grit 400

To use after HYPERSHINE EXTRA 0 for a matt finish. It also remove light scratches on concrete, marble and natural stones.

#### 2 Grit 800

To use after HYPERSHINE EXTRA 1 for a honed finish.

#### 3 Grit 1800

To use after HYPERSHINE EXTRA 2 for a semi gloss finish.

#### 4 Grit BUFF\*

To use after HYPERSHINE EXTRA 3 for a gloss finish: Grit 4 is ideal for Buffing.

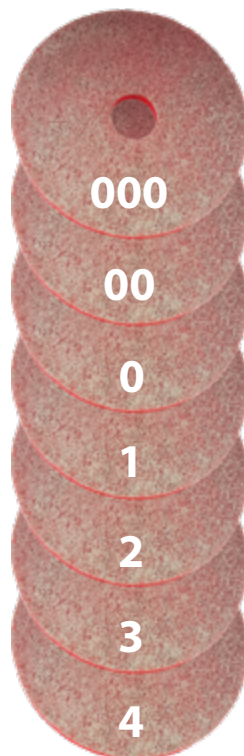

DESCRIPTION	SIZE	PRICE
HYPERSHINE EXTRA 000 GRIT 60	240mm - 9,5"	€ 48,00
HYPERSHINE EXTRA 00 GRIT 120	240mm - 9,5"	€ 48,00
HYPERSHINE EXTRA 0 GRIT 220	240mm - 9,5"	€ 48,00
HYPERSHINE EXTRA 1 GRIT 400	240mm - 9,5"	€ 48,00
HYPERSHINE EXTRA 2 GRIT 800	240mm - 9,5"	€ 48,00
HYPERSHINE EXTRA 3 GRIT 1800	240mm - 9,5"	€ 48,00
HYPERSHINE EXTRA 4 GRIT BUFF*	240mm - 9,5"	€ 48,00
HYPERSHINE EXTRA 000 GRIT 60	330mm - 13"	€ 55,00
HYPERSHINE EXTRA 00 GRIT 120	330mm - 13"	€ 55,00
HYPERSHINE EXTRA 0 GRIT 220	330mm - 13"	€ 55,00
HYPERSHINE EXTRA 1 GRIT 400	330mm - 13"	€ 55,00
HYPERSHINE EXTRA 2 GRIT 800	330mm - 13"	€ 55,00
HYPERSHINE EXTRA 3 GRIT 1800	330mm - 13"	€ 55,00
HYPERSHINE EXTRA 4 GRIT BUFF*	330mm - 13"	€ 55,00
HYPERSHINE EXTRA 000 GRIT 60	430mm - 17"	€ 70,00
HYPERSHINE EXTRA 00 GRIT 120	430mm - 17"	€ 70,00
HYPERSHINE EXTRA 0 GRIT 220	430mm - 17"	€ 70,00
HYPERSHINE EXTRA 1 GRIT 400	430mm - 17"	€ 70,00
HYPERSHINE EXTRA 2 GRIT 800	430mm - 17"	€ 70,00
HYPERSHINE EXTRA 3 GRIT 1800	430mm - 17"	€ 70,00
HYPERSHINE EXTRA 4 GRIT BUFF*	430mm - 17"	€ 70,00
HYPERSHINE EXTRA 000 GRIT 60	510mm - 20"	€ 90,00
HYPERSHINE EXTRA 00 GRIT 120	510mm - 20"	€ 90,00
HYPERSHINE EXTRA 0 GRIT 220	510mm - 20"	€ 90,00
HYPERSHINE EXTRA 1 GRIT 400	510mm - 20"	€ 90,00
HYPERSHINE EXTRA 2 GRIT 800	510mm - 20"	€ 90,00
HYPERSHINE EXTRA 3 GRIT 1800	510mm - 20"	€ 90,00
HYPERSHINE EXTRA 4 GRIT BUFF*	510mm - 20"	€ 90,00

\*Available also

**HYPERSHINE EXTRA 5 Grit 5000 and  
HYPERSHINE EXTRA 6 Grit 12000 Lux**

## DIAMOND TOOLS AND SAND PAPER



SAND PAPER Ø 150



SAND PAPER Ø 430



MESH DISC



TYTAN DISC

DESCRIPTION		PRICE				
	<p><b>High quality abrasive sand paper. High performance. Suitable for floor preparation, concrete and wooden floors.</b></p> <p><b>SAND PAPER</b> GRIT 40 Ø 150mm – 6 BOX 200 pcs € 338,00</p> <p><b>SAND PAPER</b> GRIT 60 Ø 150mm – 6 BOX 200 pcs € 298,00</p> <p><b>SAND PAPER</b> GRIT 80 Ø 150mm – 6 BOX 200 pcs € 285,00</p> <p><b>SAND PAPER</b> GRIT 100 Ø 150mm – 6 BOX 200 pcs € 255,00</p> <p><b>SAND PAPER</b> GRIT 120 Ø 150mm – 6 BOX 200 pcs € 255,00</p>					
		<p><b>High quality abrasive double face sand paper. Full resin bonded silicon carbide abrasive sand paper, for heavy duty applications. Suitable for concrete and wooden floors.</b></p> <p><b>DOUBLE-SIDED SAND PAPER</b> GRIT 16 Ø 430mm – 17" BOX 25 pcs € 550,00</p> <p><b>DOUBLE-SIDED SAND PAPER</b> GRIT 24 Ø 430mm – 17" BOX 25 pcs € 512,50</p> <p><b>DOUBLE-SIDED SAND PAPER</b> GRIT 36 Ø 430mm – 17" BOX 50 pcs € 795,00</p> <p><b>DOUBLE-SIDED SAND PAPER</b> GRIT 60 Ø 430mm – 17" BOX 50 pcs € 575,00</p> <p><b>DOUBLE-SIDED SAND PAPER</b> GRIT 80 Ø 430mm – 17" BOX 50 pcs € 525,00</p> <p><b>DOUBLE-SIDED SAND PAPER</b> GRIT 100 Ø 430mm – 17" BOX 50 pcs € 525,00</p> <p><b>DOUBLE-SIDED SAND PAPER</b> GRIT 120 Ø 430mm – 17" BOX 50 pcs € 525,00</p>				
			<p><b>High quality abrasive screens impregnated with silicon carbide abrasive. Low clogging. Excellent finish. Applications: micro cement and wooden floors.</b></p> <p><b>MESH DISC</b> GRIT 60 Ø 406mm – 16" BOX 20 pcs € 206,00</p> <p><b>MESH DISC</b> GRIT 80 Ø 406mm – 16" BOX 20 pcs € 206,00</p> <p><b>MESH DISC</b> GRIT 120 Ø 406mm – 16" BOX 20 pcs € 206,00</p> <p><b>MESH DISC</b> GRIT 220 Ø 406mm – 16" BOX 20 pcs € 206,00</p>			
				<p><b>Carbide metal disc, double-sided, high performance, high wear-resistant abrasive lasts up to 150 times longer than sand paper and much more effective and time-saving. Suitable for removing a wide range of coatings on concrete, wooden and other surfaces. To be used with holder disc for sand paper.</b></p> <p><b>TYTAN DISC</b> COARSE Ø 430mm - 17" GRIT 14 € 140,00</p> <p><b>TYTAN DISC</b> MEDIUM Ø 430mm - 17" GRIT 24 € 140,00</p> <p><b>TYTAN DISC</b> FINE Ø 430mm - 17" GRIT 36 € 140,00</p>		
					<p><b>Floor preparation disc with metal tools to be used with orbital machines.</b></p> <p><b>GRINDING PLATE WITH 3 TRAPEZOID TOOLS</b> Ø 430mm – 17" GRIT 24 € 290,00</p> <p><b>GRINDING PLATE WITH 3 TRAPEZOID TOOLS</b> Ø 430mm – 17" GRIT 36 € 290,00</p> <p><b>GRINDING PLATE WITH 6 TRAPEZOID TOOLS</b> Ø 430mm – 17" GRIT 24 € 435,00</p> <p><b>GRINDING PLATE WITH 6 TRAPEZOID TOOLS</b> Ø 430mm – 17" GRIT 36 € 435,00</p>	
						<p><b>Jumpflex Marble Polishing Pads for Marble and Natural Stone.</b></p> <p><b>JUMPFLEX MARBLE RESIN TOOLS</b> Ø 75mm – 3" Available GRITS 50 - 100 - 200 - 400 - 800 - 1500 - 3500. € 24,00</p>

## DIAMOND BRUSHES AND ACCESSORIES

	DESCRIPTION	PRICE										
	<p><b>ABRASIVE BRUSHES Ø 100mm</b></p> <p>Abrasive diamond brushes gives an antique old-look effect on marble and natural stone floors. Can be used with marble, ceramic tiles, granite and concrete floors. Use wet or dry. Available GRIT 24 - 36 - 46 - 60 - 80 - 120 - 240 - 320 - 500 / Ø 100mm - 4" AS/Velcro connection.</p>	€ 40,00										
	<p><b>ABRASIVE BRUSHES Ø 240mm</b></p> <p>Abrasive diamond brushes gives an antique old-look effect on marble and natural stone floors. Can be used with marble, ceramic tiles, granite and concrete floors. Use wet or dry. Available GRIT 24 - 36 - 46 - 60 - 80 - 120 - 240 - 320 - 500 / Ø 240mm - 9,5". Velcro connection. # for heavy machines we recommend to use grits from 24 to 46.</p>	€ 175,00										
	<p><b>FULL AUTOMATIC INTELLIGENT GLOSSMETER</b></p> <p>Indispensable digital instrument of great precision to measure the degree of gloss on polished concrete, marble, granite, terrazzo and natural stone floors.</p> <ul style="list-style-type: none"> <li>• Auto calibration</li> <li>• Auto start</li> <li>• Auto switch off</li> <li>• Easy charging system</li> <li>• Large display</li> <li>• Automatic data saving</li> <li>• Battery charger and professional blackcover bag included</li> </ul>	€ 880,00										
	<p><b>VELCRO PAD HOLDER Ø 240mm QUICK ATTACK</b></p> <p>Velcro Pad Holder for resin tools and pads.</p>	€ 78,00										
	<p><b>METAL PLATE HOLDER FOR TRAPEZOID TOOLS QUICK ATTACK</b></p> <p>Plate holder for trapezoid tools.</p>	€ 80,00										
	<p><b>PLASTIC VELCRO PAD HOLDER</b></p> <p>Plastic velcro support Ø 100mm.</p> <p>Plastic velcro support Ø 140mm.</p>	€ 21,00 € 26,50										
	<p><b>MOHS' HARDNESS PICK SET</b></p> <p>An essential tool for determining the concrete hardness (via scratch testing) and choosing the correct grinding tool!</p> <table border="1" data-bbox="491 1870 1173 2083"> <thead> <tr> <th>MOHS' SCALE</th> <th>Recommended metal bond tools</th> </tr> </thead> <tbody> <tr> <td>2-3</td> <td> Yellow bond for Soft Concrete</td> </tr> <tr> <td>3-5</td> <td> Grey bond for Medium Concrete</td> </tr> <tr> <td>5-7</td> <td> Red bond for Hard Concrete</td> </tr> <tr> <td>7-9</td> <td> Gold and White bond for Extra Hard Concrete</td> </tr> </tbody> </table>	MOHS' SCALE	Recommended metal bond tools	2-3	 Yellow bond for Soft Concrete	3-5	 Grey bond for Medium Concrete	5-7	 Red bond for Hard Concrete	7-9	 Gold and White bond for Extra Hard Concrete	€ 240,00
MOHS' SCALE	Recommended metal bond tools											
2-3	 Yellow bond for Soft Concrete											
3-5	 Grey bond for Medium Concrete											
5-7	 Red bond for Hard Concrete											
7-9	 Gold and White bond for Extra Hard Concrete											

# LEVITEK 500 Grinder

MADE in ITALY



**LEVITEK 500 GRINDER:** planetary floor grinder fitted with a powerful motor max 2900 W - 4HP and the new planetary KS140. Suitable for grinding and polishing Marble, Concrete, Granite, Gres, Terrazzo and Wooden floors, ideal for apartments and industrial areas. Compact size machine ideal for working in smaller areas like bathrooms and kitchens. Also suitable for floor preparation and coating removal.

New and modern design made in Italy, Levitek 500 GRINDER is equipped with wide and no-slip wheels for easy transport and maneuverability. Ergonomic and adjustable handle allows comfortable and practical use of the machine. Wide range of accessories for any application.

## TOOLING FOR FLOOR PREPARATION



**GRINDING RING**  
12 SEGMENTS



**GRINDING RING**  
16 SEGMENTS



**GRINDING PLATE**  
6 TRAPEZOID

## STEEL GEAR CONNECTION FOR PLANETARY KS140



**EXTRA WEIGHT 17 KG** included with the machine

## APPLICATION

- Grinding and polishing marble, concrete, terrazzo and granite floors
- Suitable for floor preparation and coatings removal
- Also suitable for cleaning, maintenance and floor restoration

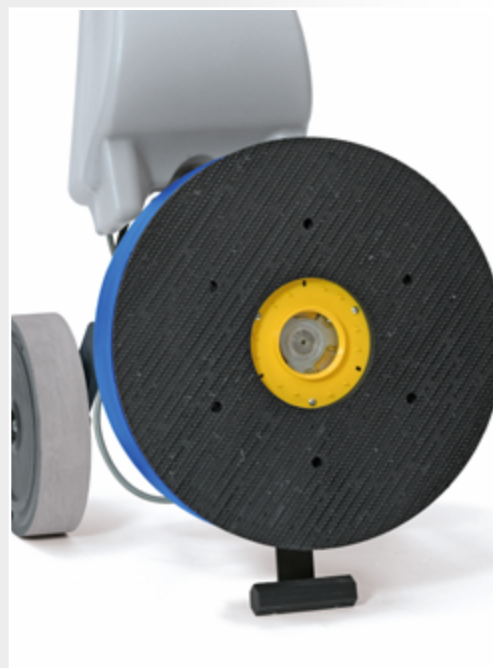

**CONVERTIBLE IN SINGLE DISC MACHINE**  
SUITABLE FOR GRINDING AND POLISHING ANY KIND OF FLOOR

# LEVITEK 500 Grinder



LEVITEK floor grinder is equipped with unidirectional removable full metal gear box planetary system. The removal of the planetarium from the floating head allows to transform Levitek from a powerful grinder to a performing single disc machine in few seconds. Levitek can use all type of diamond tools for any situation and it's compatible with all accessories for single disc machine. Levitek is 100% Made in Italy.

## MAIN FEATURES

- Working width 510mm - 20"
- Tool holders 3x140mm / 5,5"
- Planetary rotation speed 160 rpm
- Tool speed 1000 rpm
- Quick connection system
- Helicoidal steel gears
- Planetary weight 12 kg



## PLANETARY KS140 / 3 Heads

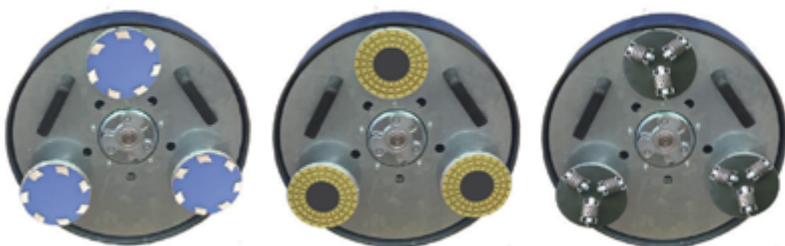

Suitable for grinding and polishing any kind of floor

Suitable also for bush-hammering  
Kit bush-hammer 3x140mm / 5,5"

## TECHNICAL DATA

Max Power	2900w - 4 Hp
Working Width	510 mm / 20"
Voltage	220-230 V / 50-60 Hz
Weight	115 Kg
Water Tank capacity	15 Lt
<b>Price</b>	<b>€ 5.330,00</b>

**Includes:** 1 weight 17 kg, Planetary KS140 (3 heads x140mm), water tank 15 Lt, cord extension and standard full velcro pad holder Ø 510mm.

# LEVITEK 500 Sander

MADE in ITALY



**LEVITEK 500 SANDER:** planetary floor sander fitted with a powerful motor max 2900 W - 4HP and the new planetary KS140. Equipped with a special vacuum system on board, suitable for grinding and sanding wooden and prefinished floors. Ideal for wooden floor, parquet, concrete preparation and microcement floors. Compact size machine also suitable for working in medium and small size areas. Ideal for floor preparation and coatings removal.

New and modern design made in Italy. Wide no-slip wheels for easy transport and maneuverability. Ergonomic and adjustable handle allows comfortable and practical use of the machine. Wide range of accessories for any application.

## MAIN ACCESSORIES

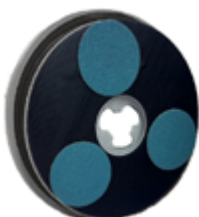

**SAND PAPER DISC**  
Ø 150mm



**GRINDING PLATE**  
Ø 510mm



**STANDARD FULL VELCRO  
PAD HOLDER** Ø 510mm

**POWERFUL PLANETARY FLOOR SANDER EQUIPPED WITH VACUUM ON BOARD SUITABLE FOR GRINDING AND SANDING ANY KIND OF FLOORS**



**PLANETARY KS140** with 3 heads x 140 mm

### APPLICATION

- Grinding and sanding wooden and prefinished floors
- Floor preparation
- Coating removal



**PLANETARY KS140** can be quickly removed to transform the machine in a powerful single disc machine.

### TECHNICAL DATA

Max Power	2900w - 4 Hp
Working Width	510 mm / 20"
Voltage	220-230 V / 50-60 Hz
Weight	115 Kg
Water Tank capacity	15 Lt
<b>Price</b>	<b>€ 6.005,00</b>

**Includes:** 1 weight 17 kg, Planetary KS140 (3 heads x140mm), cord extension, pad holder for sand paper Ø 510mm, standard full velcro pad holder Ø 510mm, complete vacuum kit: vacuum cleaner, connection hose and rubber dust guard with connection.

# PLANETARY KS140

**NEW PLANETARY KS140 designed exclusively for Levitek 500**, suitable for grinding and polishing Marble, natural stone, Terrazzo, Concrete and wooden floors. Very easy to install, thanks to its quick connection system. 3 or 4 rotating heads (140 mm / 5,5") allows to get high planarity and levelling the floor even on bad condition.

- The STEEL gear system of the Planetary KS140 doesn't need grease because it is self-lubricating.
- Planetary KS140 can be quickly removed to transform the machine in a single disc machine.

## MAIN FEATURES:

- Tool speed 1000 rpm
- Working width 510mm - 20"
- Planetary weight 12 kg
- Tool holders 3 or 4 x140mm / 5,5"
- Planetary rotation speed 160 rpm
- Helicoidal steel gears
- Quick connection tool system

## APPLICATIONS:

- Grinding and polishing all kind of surface
- Floor preparation and coatings removal
- Sanding wooden floors
- Bush-hammer

KS 140 / 3



KS 140 / 4



DESCRIPTION		PRICE	DESCRIPTION		PRICE
	<b>VACUUM KIT</b> complete with basket, dry vacuum cleaner with additional nylon filter and connection hose	€ 557,00		<b>PLANETARY KS140 / 3</b> with 3 heads x140mm / 5,5". Suitable for Levitek 500. Working width 510mm - 20". Weight 12 kg.	€ 1.135,00
	<b>CORD EXTENSION</b> <b>EU/UK PLUG</b> 15 m power cord	€ 42,00		<b>PLANETARY KS140 / 4</b> with 4 heads x140mm / 5,5". Suitable for Levitek 500. Working width 510mm - 20". Weight 12 kg.	€ 1.430,00
	<b>WATER TANK</b> 15 liter polyethylene tank	€ 110,00		<b>PLASTIC VELCRO</b> <b>PAD HOLDER</b> Ø 140mm - 5,5"	€ 26,50
				<b>PLASTIC VELCRO</b> <b>PAD HOLDER</b> Ø 140mm + RUBBER 5mm	€ 33,00
	<b>NYLON BRUSH</b> Ø 510mm / 20"	€ 107,00		<b>SAND PAPER</b> Ø 150mm - 6" Grit 40 / BOX 200 pcs	€ 389,00
				Grit 60 / BOX 200 pcs	€ 343,00
				Grit 80 / BOX 200 pcs	€ 330,00
				Grit 100-120 / BOX 200 pcs	€ 295,00
	<b>FULL VELCRO AMORTIZED</b> <b>PAD HOLDER</b> Ø 510mm / 20"	€ 110,00		<b>BUSH-HAMMER</b> Ø 140mm - 5,5" for bush-hammering, for preparing anti-slip surfaces and to remove thick resin coatings	€ 740,00
	<b>GROUTING DISC</b> Ø 510mm / 20" for grouting jointed floors	€ 335,00		<b>GRINDING PLATE</b> Ø 510mm - 20" with 6 trapezoid tools GRIT 24-36	€ 620,00

# LEVITEK 450 Grinder

MADE in ITALY



**POWERFUL PLANETARY FLOOR GRINDER**  
suitable for grinding and polishing any kind of floor

NEW PLANETARY KS100  
with 3 heads x 100 mm

**LEVITEK 450 GRINDER:** planetary floor grinder fitted with a powerful motor max 2900 W - 4HP and the new planetary KS100. Suitable for grinding and polishing Marble, Concrete, Granite, Gres, Terrazzo and Wooden floors, ideal for apartments and industrial areas. Compact size machine ideal for working in smaller areas like bathrooms and kitchens. Also suitable for floor preparation and coating removal.

New and modern design made in Italy. Wide no-slip wheels for easy transport and maneuverability. Ergonomic and adjustable handle allows comfortable and practical use of the machine. Wide range of accessories for any application.

## MAIN ACCESSORIES



**GRINDING RING**  
12 segments



**GRINDING RING**  
16 segments



**FULL VELCRO PAD HOLDER**



**GRINDING PLATE**



**TYTAN DISC**



**BUSH-HAMMER**

## STEEL GEAR CONNECTION FOR PLANETARY KS100



**EXTRA WEIGHT 17 KG** included with the machine

## APPLICATION

- Grinding and polishing marble, concrete, terrazzo and granite floors
- Suitable for floor preparation and coatings removal
- Also suitable for cleaning, maintenance and floor restoration

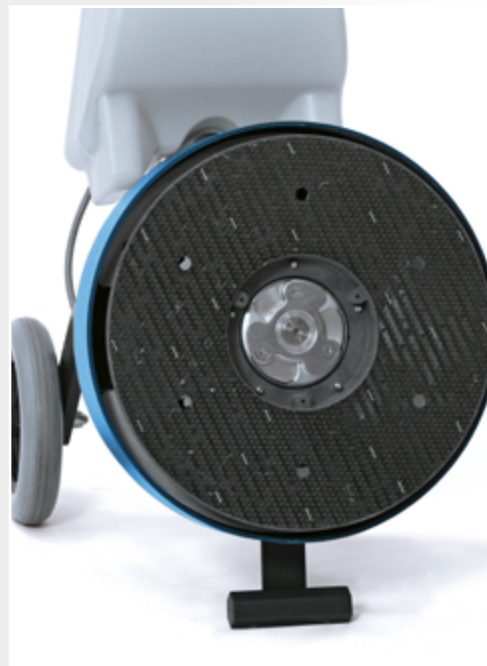

**CONVERTIBLE IN SINGLE DISC MACHINE**  
SUITABLE FOR GRINDING AND POLISHING ANY KIND OF FLOOR

# LEVITEK 450 Grinder



LEVITEK floor grinder is equipped with unidirectional removable full metal gear box planetary system. The removal of the planetarium from the floating head allows to transform Levitek from a powerful grinder to a performing single disc machine in few seconds. Levitek can use all type of diamond tools for any situation and it's compatible with all accessories for single disc machine. Levitek is 100% Made in Italy.

## MAIN FEATURES

- Working width 450mm - 18"
- Tool holders 3x100mm / 4"
- Planetary rotation speed 160 rpm
- Tool speed 1000 rpm
- Quick connection system
- Helicoidal steel gears
- Planetary weight 12 kg



**QUICK RELEASE OF THE PLANETARY**  
The PLANETARY KS100 can be quickly removed to transform the machine in a powerful single disc machine

## PLANETARY KS100 / 3 Heads



Suitable for grinding and polishing any kind of floor

## TECHNICAL DATA

Max Power	2900w - 4 Hp
Working Width	450 mm / 18"
Voltage	220-230 V / 50-60 Hz
Weight	81 Kg
Water Tank capacity	15 Lt
<b>Price</b>	<b>€ 5.085,00</b>

**Includes:** 1 weight 17 kg, KS100 Planetary (3 heads x100mm), water tank 15 Lt, cord extension and standard full velcro pad holder Ø 450mm.

# LEVITEK 450 Sander

MADE in ITALY



**LEVITEK 450 SANDER:** planetary floor grinder fitted with a powerful motor max 2900 W - 4HP and the new planetary KS100. Equipped with vacuum system on board, suitable for grinding and polishing any kind of floor. Ideal for floor grinding and preparation, glue, resin and coatings removal.

Compact size machine suitable for working in medium and small size areas. New and modern design made in Italy. Wide no-slip wheels for easy transport and maneuverability.

Ergonomic and adjustable handle allows comfortable and practical use of the machine. Wide range of accessories for any application.

## MAIN ACCESSORIES



**SAND PAPER  
PAD HOLDER**



**SAND PAPER**  
Ø 430



**MESH DISC**



**TYTAN DISC**

**POWERFUL PLANETARY FLOOR SANDER EQUIPPED WITH VACUUM ON BOARD SUITABLE FOR GRINDING AND SANDING ANY KIND OF FLOORS**



**PLANETARY KS100** with 3 heads x 100 mm

## APPLICATION

- Grinding and polishing any kind of floor
- Floor grinding and preparation
- Glue, resin and coatings removal

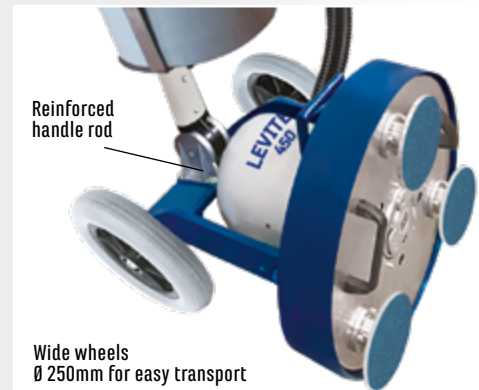

**PLANETARY KS100** can be quickly removed to transform the machine in a powerful single disc machine.

## TECHNICAL DATA

Max Power	2900w - 4 Hp
Working Width	450 mm / 18"
Voltage	220-230 V / 50-60 Hz
Weight	81 Kg
Water Tank capacity	15 Lt
<b>Price</b>	<b>€ 5.695,00</b>

**Includes:** 1 weight 17 kg, Planetary KS100 (3 heads x100mm), cord extension, pad holder for sand paper Ø 430mm, standard full velcro pad holder Ø 430mm, complete vacuum kit: vacuum cleaner, connection hose and rubber dust guard with connection.

# PLANETARY KS100

New Planetary KS100 designed exclusively for Levitek 450, suitable for grinding and polishing Marble, natural stone, Terrazzo, Concrete and wooden floors. Very easy to install, thanks to its quick connection system. The 3 rotating heads (100 mm / 4") allows to get high planarity and levelling the floor even on bad condition.

- The gear system of the Planetary KS100 doesn't need grease because it is self-lubricating.
- Planetary KS100 can be quickly removed to transform the machine in a single disc machine.

## MAIN FEATURES:

- Tool speed 1000 rpm
- Working width 450mm - 18"
- Planetary weight 12 kg
- Tool holders 3 x100mm / 4"
- Planetary rotation speed 160 rpm
- Helicoidal steel gears
- Quick connection tool system

## APPLICATIONS:

- Grinding and polishing all kind of surface
- Floor preparation and coating removal
- Sanding wooden floors
- Bush-hammer



DESCRIPTION		PRICE	DESCRIPTION		PRICE
	<b>VACUUM KIT</b> complete with basket, dry vacuum cleaner with additional nylon filter and connection hose	€ 556,00		<b>PLANETARY KS100</b> with 3 heads x100mm / 4" Suitable for Levitek 450. Working width 450mm - 18". Weight 12 kg.	€ 1060,00
	<b>WATER TANK</b> 15 liter polyethylene tank	€ 106,00		<b>PLASTIC VELCRO PAD HOLDER</b> Ø 100mm - 4"	€ 21,00
	<b>NYLON BRUSH</b> Ø 430mm / 17"	€ 53,00		<b>DOUBLE-SIDED SAND PAPER</b> Ø 430mm - 17" / Grit 16 / BOX 25 pcs Grit 24 / BOX 25 pcs Grit 36 / BOX 50 pcs Grit 60 / BOX 50 pcs Grit 80-100-120 / BOX 50 pcs	€ 550,00 € 512,50 € 795,00 € 575,00 € 525,00
	<b>FULL VELCRO PAD HOLDER</b> Ø 430mm / 17"	€ 95,00		<b>MESH DISC</b> Ø 406mm - 16" Grit 60-80-120-220 BOX 20 pcs	€ 206,00
	<b>PAD HOLDER FOR SAND PAPER</b> Ø 430mm / 17"	€ 112,00		<b>TYTAN DISC</b> Ø 430mm - 17" COARSE (Grit 14) / MEDIUM (Grit 24) FINE (Grit 36)	€ 129,00
	<b>BUSH-HAMMER</b> Ø 430mm / 17" for bush-hammering, for preparing anti-slip surfaces and to remove thick resin coatings	€ 1.440,00		<b>GRINDING PLATE</b> Ø 430mm - 17" with 6 trapezoid tools GRIT 24-36	€ 485,00

# MAXI ORBITAL 430



**MAXI ORBITAL 430** is an innovative single disc machine, suitable for heavy duty cleaning tasks. The machine uses an orbital movement which increases the productivity compared with a traditional single disc machine. By using high frequency oscillations, this machine offers excellent stability and maneuverability, despite a total weight of 65 kg, (not including accessories).

When working with water, the **MAXI ORBITAL 430** enables considerable savings as the water is constantly held within the disc area by the orbital movement, and is not dispersed.

In addition, the distinctive orbital movement makes it very easy for any operator to use the **MAXI ORBITAL 430** machine, reducing training times and eliminating the need for any particular degree of physical strength.

The low current absorption of this machine means that it can even be used together with a vacuum cleaner, with both appliances powered by standard mains voltage. **MAXI ORBITAL 430** enables several operations to be performed using the same machine, simply by changing the accessories.



Carpet cleaning

Daily floor maintenance



Coatings removal

Floor grinding and polishing

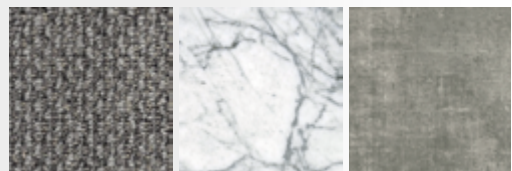

Carpet cleaning

Marble and Granite restoration

Concrete grinding and polishing

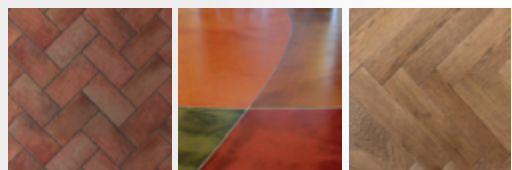

Ceramic, Terracotta and Klinker

Resin restoration and removal

Parquet sanding and restoration

## TECHNICAL DATA

Drive	Direct Drive
Working width	430mm
Brush Ø	430mm
Pad holder Ø	430mm
Oscillations per minute n.	1400
Power supply	230 V 50/60 Hz*
Tank	15 Lt
Power	1100 W
Machine weight	65 Kg

\*available also 120 V / 60 Hz



It used up to 1/10 the water of traditional single disc machines.

The consumption of chemicals is automatically reduced.

Working times and electricity consumption are reduced by around 40%

Less water, less detergent, less energy, less time, less manpower.

### WHY CHOOSE A SINGLE DISC MACHINE WITH ROTO-ORBITAL SYSTEM?

- **Two movements in one: roto-orbital**

Simultaneous to the natural rotary movement of the disc, which can vary from 0 to 90 rpm, the system always generates a constant orbital movement that allows to pass very quickly over the same point many times. On surfaces such as hard floors, resilient floors, wood, resin and carpet floors, it creates rotational movements with a diameter of about 1 cm, with 1400 passes per minute. This guarantees an extraordinary and rapid scrubbing, polishing, crystallizing performance, etc. The innovative orbital technology guarantees an intense and delicate cleaning.

- **Perfect adhesion to the surface**

The working area is always constant and the brush/disc always remains level with respect to the surface, adhering perfectly.

- **Forward and backward movement and easy slewing**

The action of the brush is effective during any movement: forward and backward or slewing, staying flat on the surface at all times.

- **Less use of water and detergent**

The orbital movement holds the water inside the disc and is not sprayed outside. Thanks to this technology the consumption of water and consequently that of detergent is drastically reduced.

- **Low energy consumption**

Maximum absorption of 2,5-3 Ah.

- **A single machine for multiple functions**

The roto-orbital system ensures that all operations are carried out on various types of floor thanks to its versatility and the availability of specific accessories that make the machine multi-purpose.



## MAXI ORBITAL 430 Sander

Thanks to the complete range of accessories and discs, **MAXI ORBITAL 430** satisfies the continuous requirements of the sanding world and more frequent demands for new finishes. Besides the traditional parquet sanding, by using sandpapers **MAXI ORBITAL 430** is exceptionally efficacious also on all the types of pre-finished parquet.

**MAXI ORBITAL 430** can remove the varnish layer leaving entirely intact the noble part of the wood, in order to guarantee the chance of re-sanding other 2 or 3 times. **MAXI ORBITAL 430** does not leave signs and allows a good finishing since the first step. The following steps will allow the operator to save time guaranteeing an excellent result. The immense range of abrasives and diamond accessories of **MAXI ORBITAL 430** allow to perform the following works: resins and glue removal; floor sanding; floor polishing.



**MAXI ORBITAL 430 SANDER** including vacuum kit complete with basket, vacuum cleaner with additional nylon filter, connection hose and velcro dust guard with bristles. Ideal for wooden floor, parquet, concrete and microcement floors.

# MAXI ORBITAL 430

**NEW  
REVOLUTIONARY**

SINGLE DISC MACHINE  
with  
ROTO-ORBITAL SYSTEM



DESCRIPTION	MAXI ORBITAL 430 BASIC	MAXI ORBITAL 430 EXTRA*	MAXI ORBITAL 430 EXTRA* SANDER
<b>Drive</b>	Direct Drive	Direct Drive	Direct Drive
<b>Working width</b>	430mm - 17"	430mm - 17"	430mm - 17"
<b>Power 230 V 50/60 Hz#</b>	1100 W 1,5 Hp	1100 W 1,5 Hp	1100 W 1,5 Hp
<b>Disc rotation speed</b>	0-90 rpm	0-90 rpm	0-90 rpm
<b>Oscillations / min.</b>	1400	1400	1400
<b>Brush Ø</b>	430mm - 17"	430mm - 17"	430mm - 17"
<b>Pad holder Ø</b>	430mm - 17"	430mm - 17"	430mm - 17"
<b>Tank capacity</b>	15 Lt	15 Lt	15 Lt
<b>Weight</b>	65 Kg	65 Kg	65 Kg
<b>Extra weight</b>	17 Kg	17 Kg	17 Kg
<b>PRICE</b>	<b>€ 1.955,00</b> Includes 1 weight 17 Kg	<b>€ 2.205,00</b> Includes 1 weight 17 Kg	<b>€ 2.670,00</b> Includes 1 weight 17 Kg + Vacuum Kit

\*EXTRA: with quick release of the head from the trolley, quick unlock of the weight and fast disconnection of the electrical system.

# Version available also with 120 V / 60 Hz

## MAXI ORBITAL 430 EXTRA\* SPRAY

**Price € 2.345,00**

in addition to the features of EXTRA\*, Spray version it is equipped with a pump and 2 adjustable nozzles, a two-position switch and water tank.

### ACCESSORIES MAXI ORBITAL 430

	Price
* Cord extension EU/UK plug	€ 40,50
* Tank 15 Lt	€ 106,00
* Brush Ø 430mm - 17"	€ 72,00
* Standard full velcro Pad holder Ø 430mm - 17"	€ 112,00
Tynex brush gr 120	€ 214,00
Full velcro amortized Pad holder Ø 430mm - 17"	€ 94,00
Pad holder for steel wool Ø 430mm - 17"	€ 147,00
Pad holder for sand paper Ø 430mm - 17"	€ 157,00
Kit extra weight 17 Kg	€ 180,00
Complete vacuum kit + dry vacuum + rubber hood	€ 465,00
**** Complete standard kit Ø 430mm - 17"	€ 330,50



# MAXI ORBITAL 500

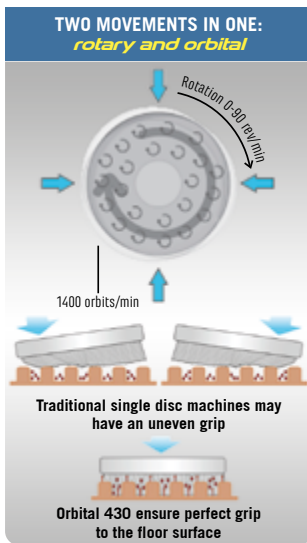

DESCRIPTION	MAXI ORBITAL 430 / 500 BASIC DUAL SPEED	MAXI ORBITAL 500 EXTRA*	MAXI ORBITAL 500 EXTRA* SPRAY
<b>Drive</b>	Direct Drive	Direct Drive	Direct Drive
<b>Working width</b>	430/500mm - 17"/20"	500mm - 20"	500mm - 20"
<b>Power 230 V 50/60 Hz#</b>	1100 W 1,5 Hp	1100 W 1,5 Hp	1100 W 1,5 Hp
<b>Disc rotation speed</b>	0-90/180 rpm	0-90 rpm	0-90 rpm
<b>Oscillations / min.</b>	1400/2800	1400	1400
<b>Brush Ø</b>	430/500mm - 17"/20"	500mm - 20"	500mm - 20"
<b>Pad holder Ø</b>	430/500mm - 17"/20"	500mm - 20"	500mm - 20"
<b>Tank capacity</b>	15 Lt	15 Lt	15 Lt
<b>Weight</b>	65 / 68 Kg	68 Kg	68 Kg
<b>Extra weight</b>	17 Kg	17 Kg	17 Kg
<b>PRICE</b>	<b>500 Basic DS € 2.325,00</b> <b>430 Basic DS € 2.320,00</b>	<b>€ 2.230,00</b> Includes 1 weight 17 Kg	<b>€ 2.355,00</b> Includes 1 weight 17 Kg + Vacuum Kit

\*EXTRA: with quick release of the head from the trolley, quick unlock of the weight and fast disconnection of the electrical system.

# Version available also with 120 V / 60 Hz

MAXI ORBITAL 500 EXTRA\* SPRAY: in addition to the features of EXTRA\*, Spray version it is equipped with a pump and 2 adjustable nozzles, a two-position switch and water tank.



### DUAL SPEED BUTTON

By pressing the DS Dual Speed button, the number of orbits changes from 1400 to 2800 orbits/min. This speed is recommended for dry polishing and crystallization operations.

### PUMP FOR EXTRA SPRAY

Extra Spray version, with two adjustable nozzles. Uses a draw pipe with filter in the 15 liter solution tank.

### ACCESSORIES MAXI ORBITAL 500

ACCESSORIES MAXI ORBITAL 500	Price
* Cord extension EU/UK plug	€ 40,50
* Tank 15 Lt	€ 106,00
* Nylon brush Ø 500mm - 20"	€ 90,00
* Full velcro amortized Pad holder Ø 500mm - 20"	€ 126,00
Standard full velcro Pad holder Ø 500mm - 20"	ND
Pad holder for steel wool Ø 500mm - 20"	ND
Pad holder for sand paper Ø 500mm - 20"	ND
Kit extra weight 17 Kg	€ 180,00
Complete vacuum kit + dry vacuum + rubber hood	€ 465,00
**** Complete standard kit Ø 500mm - 20"	€ 362,50

# ORBITAL 430

It is not just a cleaning machine, but a cleaning system. Easy to use, it ensures high performance on every surface. It is easy to transport and to operate without tiring the operator. ORBITAL 430 SPRAY is provided with adjustable nozzles to control water consumption.

## ORBITAL 430

## ORBITAL 430 SPRAY



The Spray Kit is fitted on the ORBITAL 430 Spray version.

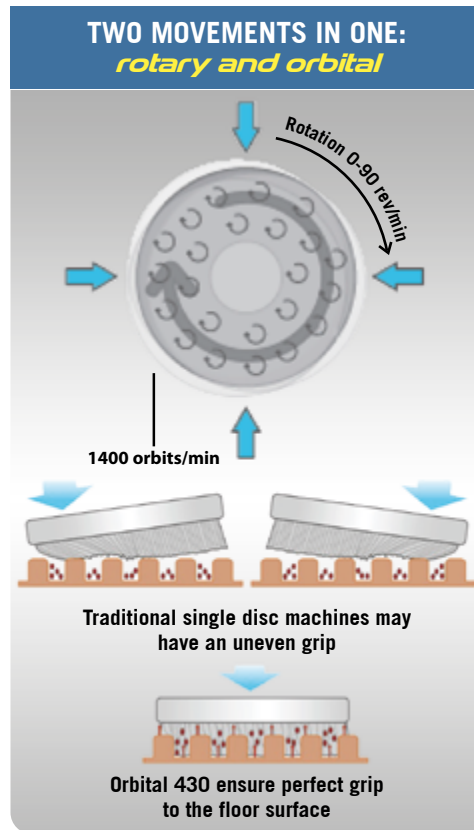

**ORBITAL 430** is a newly devised single disc machine. Its rotary orbital motion improves performance compared to traditional single disc machines. Thanks to principle of high-frequency oscillations, excellent stability and maneuverability are ensured despite its total weight of 42 Kg.

During tasks requiring water, **ORBITAL 430** ensures considerable water savings as water is constantly kept within the disc area, without being dispensed. In addition to that, this peculiar orbital motion makes **ORBITAL 430** extremely user-friendly for any operator, with reduced times for technical training on the machine.

Thanks to its low consumption, it can also be used in combination with a vacuum cleaner, both being powered by a standard domestic mains supply. Through motion a vibration is created which ensures extraordinary cleaning, smoothing and polishing performance.

This innovative orbital technology ensures thorough and delicate cleaning. Each contact with the floor creates a 1 cm wide circular motion, with as many as 1400 rotations per minute. The cleaning effect increases, also other factors, such as time, water, chemicals and temperature, decrease drastically.



TECHNICAL DATA	ORBITAL 430	ORBITAL 430 SPRAY
Drive	Direct Drive	Direct Drive
Working width	430mm	430mm
Brush Ø	430mm	430mm
Pad holder Ø	430mm	430mm
Oscillations per minute n.	1400	1400
Power supply	230 V 50/60 Hz*	230 V 50/60 Hz*
Tank	15 Lt	15 Lt
Power	1100 W	1100 W
Machine weight	42 Kg	42 Kg

\*available also 120 V / 60 Hz

# ORBITAL 430

**NEW  
REVOLUTIONARY**

**SINGLE DISC MACHINE  
with  
ROTO-ORBITAL SYSTEM**



DESCRIPTION	ORBITAL 430	ORBITAL 430 <b>SPRAY*</b>
<b>Drive</b>	Direct Drive	Direct Drive
<b>Working width</b>	430mm - 17"	430mm - 17"
<b>Power 230 V 50/60 Hz#</b>	1100 W 1,5	1100 W 1,5
<b>Disc rotation speed</b>	Hp	Hp
<b>Oscillations / min.</b>	0-90 rpm	0-90 rpm
<b>Brush Ø</b>	1400	1400
<b>Pad holder Ø</b>	430mm - 17"	430mm - 17"
<b>Tank capacity</b>	15 Lt	15 Lt
<b>Weight</b>	42 Kg	42 Kg
<b>Extra weight</b>	-	-
<b>PRICE</b>	<b>€ 1.565,00</b> Includes cord extension, water tank, nylon brush and standard velcro pad holder	<b>€ 1.805,00</b> Includes cord extension, water tank, nylon brush and standard velcro pad holder

\***ORBITAL 430 SPRAY:** is equipped with a pump and 1 adjustable nozzle, a two-position switch and water tank.

# Version available also with 120 V / 60 Hz



### 3-POSITION BUTTON

Allows continuous, neutral or intermittent delivery.



### SPRAY KIT

Equipped with pump, nozzle to adjust the spray of the solution and a control button on the handle. The Spray Kit is not supplied separately but fitted on the ORBITAL 430 Spray version.

ACCESSORIES ORBITAL 430	Price
* Cord extension EU/UK plug	€ 40,50
* Tank 15 Lt	€ 106,00
* Nylon brush Ø 430mm - 17"	€ 81,00
* Standard full velcro Pad holder Ø 430mm - 17"	€ 112,00
Full velcro amortized Pad holder Ø 430mm - 17"	€ 94,00
Pad holder for steel wool Ø 430mm - 17"	€ 147,00
Pad holder for sand paper Ø 430mm - 17"	€ 157,00
**** Complete standard kit Ø 430mm - 17"	€ 340,00

# ORBITAL PLUS<sup>+</sup>

Recommended for maintenance, deep cleaning, treatments and non-routine maintenance operations. Single or dual speed models for dry polishing and crystallization. Suction kit available for wood floor sanding.

## ORBITAL PLUS

## ORBITAL PLUS SANDER



**ORBITAL PLUS** models benefit the orbital mechanism to obtain optimal stability, ease of use and great maneuverability, even for no-expert operators. **ORBITAL PLUS** models with their weight of 50 kg and the option of connection to a vacuum unit, are suitable for a wider range of applications: dust-free sanding and restoration of wood floors, and reduced work times for smoothing and polishing marble. Ideal for washing, polishing, dewaxing, crystallization and restoration of marble floors, and for carpet washing.

**ORBITAL PLUS** has the benefits of orbital technology, such as: energy saving, water and detergent saving, and significant reduction of labor costs.

### FLOOR TREATMENT FOR ANY KIND OF SURFACES

- Scrubbing
- Re-smoothing
- Polishing
- Crystallization

#### TECHNICAL DATA

Drive	Direct Drive	Power supply	230 V 50/60 Hz*
Working Width	430 mm	Tank	15 Lt
Brush Ø	430 mm	Power	1100 W
Oscillations per minute n.	1400	Machine weight	50 Kg



### ORBITAL PLUS DUAL SPEED

The first speed is for washing, sanding, polishing and crystallization. The second speed greatly accelerates dry polishing and crystallization operations.

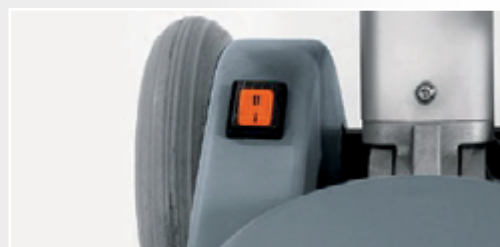

### DUAL SPEED SWITCH

Changes the orbital speed from 1400 to 2800 oscillations per minute, the correct speed for dry polishing and floor crystallization treatments.



### OPTIONAL SIDE CONNECTION CUFF

for vacuum kit. Simple insertion of vacuum hose.



### 3-POSITION BUTTON

Allows continuous, neutral or intermittent delivery.

# ORBITAL PLUS<sup>+</sup>

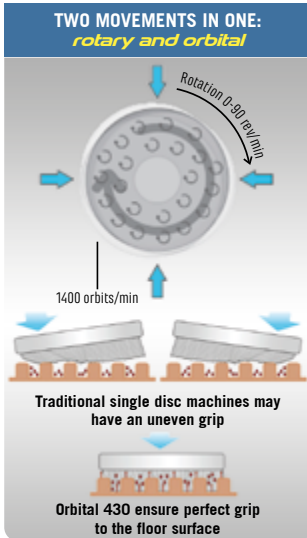

DESCRIPTION	ORBITAL PLUS BASIC	ORBITAL PLUS SPRAY	ORBITAL PLUS SANDER
<b>Drive</b>	Direct Drive	Direct Drive	Direct Drive
<b>Working width</b>	430mm - 17"	430mm - 17"	430mm - 17"
<b>Power 230 V 50/60 Hz<sup>#</sup></b>	1100 W 1,5 Hp	1100 W 1,5 Hp	1100 W 1,5 Hp
<b>Disc rotation speed</b>	0-90 rpm	0-90 rpm	0-90 rpm
<b>Oscillations / min.</b>	1400	1400	1400
<b>Brush Ø</b>	430mm - 17"	430mm - 17"	430mm - 17"
<b>Pad holder Ø</b>	430mm - 17"	430mm - 17"	430mm - 17"
<b>Tank capacity</b>	15 Lt	15 Lt	15 Lt
<b>Weight</b>	50 Kg	51 Kg	50 Kg
<b>PRICE</b>	<b>€ 1.650,00</b> Not includes any accessory	<b>€ 1.850,00</b> With pump and adjustable nozzle, handle switch and tank	<b>€ 2.115,00</b> Includes Vacuum Kit

\*EXTRA: with quick release of the head from the trolley, quick unlock of the weight and fast disconnection of the electrical system.

# Version available also with 120 V / 60 Hz



**ORBITAL PLUS SANDER VACUUM KIT**  
complete with basket, vacuum cleaner with additional nylon filter, connection hose and velcro dust guard with bristles. Ideal for wooden floor, parquet, concrete and microcement floors.

## ACCESSORIES

ACCESSORIES	Price
* Cord extension EU/UK plug	€ 40,50
* Tank 15 Lt	€ 106,00
* Nylon brush Ø 430mm (0,45 mm)	€ 81,00
* Standard full velcro Pad holder Ø 430mm	€ 112,00
Full velcro amortized Pad holder Ø 430mm	€ 95,00
Pad holder for steel wool Ø 430mm	€ 147,00
Pad holder for sand paper Ø 430mm	€ 157,00
Vacuum kit + dry vacuum + rubber hood	€ 465,00
**** Complete standard kit Ø 430mm - 17"	€ 340,00

# SINGLE DISC MACHINES

**Easy Line**

**Easy Line KP43** is a Single Disc Machines Line very solid and easy maintenance. With a stainless steel shell and PPL upholstery, they combine efficiency and versatility together with a modern ergonomics. Just model KP43G can be equipped with a 7 Kg extra weight code 224889, upon request. Moreover, the removable power cable makes transport and maintenance easier.



**Ergonomic and user friendly**



**Affordable**



**Robust**



**Versatile**



**Quiet**



The off-set position of the engine ensures a well-balanced weight distribution.

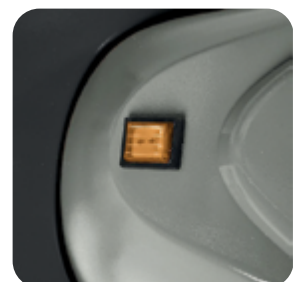

Available also the **KP43 DS 180** or 400 rpm dual speed version.



Adjustable handle for the best operating posture.



Protection for drive system.



Water distribution in the middle.

TECHNICAL DATA	KP 43 160 rpm	KP 43 180 rpm	KP 43 400 rpm	KP 43 DS 2 speed
Drive	Nylon gear	Belt	Belt	Belt
Rated power 230V 50/60Hz*	1100 W	1100 W	1400 W	1250/1700 W
Rated power	1,5 Hp	1,5 Hp	2 Hp	2,5 Hp
Speed	160 rpm	180 rpm	400 rpm	180/400 rpm
Brush Ø	430mm	430mm	430mm	430mm
Pad holder Ø	430mm	430mm	430mm	430mm
Tank capacity	15 Lt	15 Lt	15 Lt	15 Lt
Weight	35 Kg	35 Kg	35 Kg	35 Kg
Extra weight	7 Kg	-	-	-

\*available also 120 V / 60 Hz

KF 43



KF 33



KS 43 PLUS



► Heavy Line recommended for **HEAVY DUTY WORKS**

**KF 43** and **KF 33** has a steel shell and combines an high power motor with very compact dimensions, in order to grant a excellent finishing even in narrow spaces. Highly versatile.

**Working size 330mm or 430mm.**

**KS 43 PLUS** models have an aluminum base for a better resistance to chemicals and a steel gear box. Upon request each machine can be equipped with extra weight of 2 Kg (kit code 224932), and the removable power cable makes transport and maintenance easier.

**Working size 430mm. KS 43 PLUS is available:**

**1100 W - 1,5 Hp / 1800 W - 2,5 Hp / 2200 W - 3 Hp**

Nylon gear drive for **KF 43** and **KF 33**



Steel gear drive for **KS 43 PLUS**

TECHNICAL DATA	KF 43	KF 33	KS 43 PLUS
Drive	Nylon gear	Nylon gear	Steel gear
Rated power 230V 50/60Hz*	1100 W	1100 W	1100/1800/2200 W
Rated power	1,5 Hp	1,5 Hp	1,5/2,5/3,0 Hp
Speed	160 rpm	160 rpm	160 rpm
Brush Ø	430mm	330mm	430mm
Pad holder Ø	430mm	330mm	430mm
Tank capacity	15 Lt	15 Lt	15 Lt
Weight	42 Kg	35 Kg	42 Kg
Extra weight	4 Kg	-	2 Kg

\*available also 120 V / 60 Hz

**KS 50 PLUS**



**K UHS 1500 V**



High Speed  
Polisher  
1500 rpm

► **Heavy Line recommended for HEAVY DUTY WORKS**

**KS 50 PLUS** model have an aluminum base for a better resistance to chemicals and a steel gear box. Upon request each machine can be equipped with extra weights up to 4 Kg, and the removable power cable makes transport and maintenance easier.

**Working size 510mm. KS 50 PLUS is available:**  
1100 W - 1,5 Hp / 1800 W - 2,5 Hp / 2200W - 3 Hp



Steel gear drive for **KS 50 PLUS**

**KS 50 PLUS**, extra weights can be added to enhance scrubbing performance



**K UHS 1500 V** Dust control available

**K UHS 1500 V** is a high speed polisher that offers developed technological solutions to improve performance and comfort of the operator. The base is counterbalanced by a gas spring that improves the contact between disc's surface and floor, getting rid of the need of any inconvenience that might be caused by a front wheel. In this way the handle, free of any constraint, offers the operator a remarkable comfort when working. The removable power cable makes transport and maintenance easier.

**Working size 510mm.**

TECHNICAL DATA	KS 50 PLUS	K UHS 1500 V
Drive	Steel gear	Direct Drive
Rated power 230V 50/60Hz*	1100/1800/2200 W	1100 W
Rated power	1,5/2,5/3,0 Hp	1,5 Hp
Speed	160 rpm	1500 rpm
Brush Ø	510mm	-
Pad holder Ø	510mm	510mm
Tank capacity	15 Lt	-
Weight	45 Kg	38 Kg
Extra weight	4 Kg	-

\*available also 120 V / 60 Hz

# SINGLE DISC MACHINES



KP 43

KP 43 G

KF 33

KF43 / KS 43 PLUS

KS 50 PLUS

K UHS 1500 V/S  
High Speed polisher

KP · Stainless steel shell and Ppl upholstery

KF · Steel shell

KS · Aluminum base

## Easy Line

DESCRIPTION	KP 43 G 160 rpm	KP 43 180 rpm	KP 43 400 rpm	KP 43 DS dual speed
Drive	Nylon gear	Belt	Belt	Belt
Speed	160 rpm	180 rpm	400 rpm	180/400 rpm
Rated power 230 V 50/60 Hz*	1100 W 1,5 Hp	1100 W 1,5	1400 W 2 Hp	1250/1700 W 2,5
Brush Ø	430mm	Hp	430mm	Hp
Pad holder Ø	430mm	430mm	430mm	430mm
Tank capacity	15 Lt	15 Lt	15 Lt	15 Lt
Weight	35 Kg	35 Kg	35 Kg	35 Kg
Extra weight	7 Kg	-	-	-
PRICE (accessories not included)	€ 956,00	€ 920,00	€ 1.060,00	€ 1.278,00

\* Version available also with 120 V / 60 Hz

## Heavy Line

DESCRIPTION	KF 33	KF 43	KS 43 PLUS	KS 50 PLUS	K UHS 1500 S/V
Drive	Nylon gear	Nylon gear	Steel gear	Steel gear	Direct Drive
Speed	160 rpm	160 rpm	160 rpm	160 rpm	1500 rpm
Rated power 230 V 50/60 Hz*	1100 W 1,5 Hp	1100 W 1,5 Hp	a) 1100 W 1,5 Hp b) 1800 W 2,5 Hp c) 2200 W 3,0 Hp	a) 1100 W 1,5 Hp b) 1800 W 2,5 Hp c) 2200 W 3,0 Hp	1100 W 1,5 Hp
Brush Ø	330mm	430mm	430mm	510mm	-
Pad holder Ø	330mm	430mm	430mm	510mm	510mm
Tank capacity	15 Lt	15 Lt	15 Lt	15 Lt	-
Weight	35 Kg	42 Kg	42 Kg	45 Kg	38 Kg
Extra weight	-	4 Kg	2 Kg	4 Kg	-
PRICE (accessories not included)	€ 1.022,00	€ 1.060,00	a) € 1.425,00 b) € 1.585,00 c) € 1.698,00	a) € 1.475,00 b) € 1.638,00 c) € 1.755,00	S € 2.057,00 V € 2.178,00 pad holder included

\* Version available also with 120 V / 60 Hz

ACCESSORIES	Price	ACCESSORIES	Price
* Cord extension EU/UK plug	€ 40,50	Nylon brush Ø 330mm	€ 51,00
* Nylon brush Ø 430mm	€ 51,00	Standard velcro Pad holder Ø 330mm	€ 81,00
* Tank 15 Lt	€ 106,00	Pad holder for sand paper Ø 430mm	€ 111,00
* Standard velcro Pad holder Ø 430mm	€ 93,50	**** Complete standard kit Ø 430mm	€ 291,00

# Professional Vacuum

## Compact Extra



XP 530 WD

XP 560 WD

XP 580 WD

XP 7110.2 WD  
XP 7110.3 WD

XP 5110.2 WD\*  
XP 5110.3 WD\*

Professional vacuum cleaners equipped with **ROTATIONAL POLYPROPYLENE DRUM**. This specific and very robust tank guarantees strength and durability over time. Available Wet & Dry versions, with 1, 2 and 3 motors, to meet every cleaning need. Capacity tank 30 Lt, 60 Lt, 80 Lt up to 110 Lt. Applications: general cleaning sector, also suitable for heavy applications.

**Pro Team Extra Line** is specifically made to collect large quantities of water and mud especially those created during floor grinding procedures. Ideal to connect with grinding and polishing machines working "wet system" and with drilling machines.



### SHIFT & CLEAN

Special filter cleaning system with "REVERSE FLOW" for saving time of the operator who does not have to open the machine for this indispensable maintenance operation.

System equipped for models:  
XP 5110.2 WD and XP 5110.3 WD



Kit Wet & Dry Ø 37mm code 225438

Kit Wet & Dry Ø 40mm code 225439



Traditional poly filters washable + cartridge optional.

### TECHNICAL DATA

MODEL	Type	Motor num.	Max Power	Voltage - Frequency	Air flow l/s	Water lift mmH2O	Capacity	Price
XP 530 WD	W&D	1	1100 W	230-240 V - 50/60 Hz	54	2400	30 Lt	€ 408,00
XP 560 WD	W&D	1	1100 W	230-240 V - 50/60 Hz	54	2400	60 Lt	€ 417,00
XP 580 WD	W&D	1	1100 W	230-240 V - 50/60 Hz	54	2400	80 Lt	€ 585,00
XP 7110.2 WD	W&D	2	2200 W	230-240 V - 50/60 Hz	108	2400	110 Lt	€ 762,00
XP 7110.3 WD	W&D	3	3300 W	230-240 V - 50/60 Hz	148	2400	110 Lt	€ 821,00
XP 5110.2 WD*	W&D	2	2200 W	230-240 V - 50/60 Hz	108	2400	110 Lt	€ 792,00
XP 5110.3 WD*	W&D	3	3300 W	230-240 V - 50/60 Hz	148	2400	110 Lt	€ 850,00

# Professional Vacuum

## Proteam Line



P 711 D  
P 511 WD



P 712 D  
P 512 WD



P 525 WD



P 527 WD



P 540 WDM



P 750.2 WDM S\*  
P 750.3 WDM S\*

## Plast



A 711 D  
A 511 WD



A 527 WD



A 750.2 WD



A 750.2 WDM S\*  
A 750.3 WDM S\*



### FRONT MOUNTED KIT SQUEEGEE

The front fixed squeegee accessory is also available to easily suck up liquids on large surfaces.

**COD. 226890 - € 394,00**

## Inox

Professional vacuum cleaners available with polypropylene or stainless steel tank. Capacity tank from 22 Lt to 66 Lt. 1-2-3 motors. Dry and Wet & Dry versions to meet every cleaning need. Versions available with fixed trolley or market version. Standard front hose drain kit to facilitate emptying operations for WDM trolley version. Traditional poly filters washable + cartridge optional.



### TECHNICAL DATA

MODEL *S: HOSE DRAIN KIT	Type	Motor num.	Max power	Stages	Air flow l/s	Water lift mm H2O	Capacity tank	Accessories included	Price
<b>PLASTIC TANK</b>									
P 711 D	DRY	1	800 W	single	40	2200	22 Lt	Kit Ø 37mm	€ 252,00
P 711 D 1200 W	DRY	1	1200 W	double	54	2400	22 Lt	Kit Ø 37mm	€ 254,00
P 511 WD	W&D	1	1200 W	double	54	2400	22 Lt	Kit Ø 37mm	€ 297,00
P 712 D	DRY	1	800 W	single	54	2200	25 Lt	Kit Ø 37mm	€ 237,00
P 712 D 1200 W	DRY	1	1200 W	double	54	2400	25 Lt	Kit Ø 37mm	€ 239,00
P 512 WD	W&D	1	1200 W	double	54	2400	25 Lt	Kit Ø 37mm	€ 271,00
P 525 WD	W&D	1	1200 W	double	54	2400	35 Lt	Kit Ø 37mm	€ 285,00
P 527 WD	W&D	1	1200 W	double	54	2400	35 Lt	Kit Ø 40mm	€ 312,00
P 540 WDM	W&D	1	1200 W	double	54	2400	60 Lt	Kit Ø 40mm	€ 448,00
P 750.2 WDM S*	W&D	2	2400 W	double	108	2400	65 Lt	Kit Ø 40mm	€ 544,00
P 750.3 WDM S*	W&D	3	3300 W	double	148	2400	65 Lt	Kit Ø 40mm	€ 603,00
<b>INOX TANK</b>									
A 711 D	DRY	1	800 W	single	40	2200	22 Lt	Kit Ø 37mm	€ 278,00
A 711 D 1200 W	DRY	1	1200 W	double	54	2400	22 Lt	Kit Ø 37mm	€ 279,00
A 511 WD	W&D	1	1200 W	double	54	2400	22 Lt	Kit Ø 37mm	€ 323,00
A 527 WD	W&D	1	1200 W	double	54	2400	35 Lt	Kit Ø 40mm	€ 333,00
A 750.2 WD	W&D	2	2400 W	double	108	2400	66,5 Lt	Kit Ø 40mm	€ 508,00
A 750.2 WDM S*	W&D	2	2400 W	double	108	2400	66,5 Lt	Kit Ø 40mm	€ 575,00
A 750.3 WDM S*	W&D	3	3300 W	double	148	2400	66,5 Lt	Kit Ø 40mm	€ 634,00

# Professional Vacuum



**QUICK** Professional vacuum cleaners with “QUICK CLEAN SYSTEM“ to clean perfectly the filter without opening the vacuum. Standard M class filter cartridge fitted inside the head, not in contact with liquids. This allows the operator to work no-stop and suck up solids and liquids.



QUICK CLEAN SYSTEM

TECHNICAL DATA						
MODEL	Type	Motor num.	Max power	Capacity tank	Accessories included	Price
QUICK P12	W&D	1	1200 / 1400 W	25 Lt	Kit Ø 37mm	€ 305,00
QUICK P25	W&D	1	1200 / 1400 W	35 Lt	Kit Ø 40mm	€ 325,00
QUICK P35	W&D	1	1600 / 1800 W	45 Lt	Kit Ø 40mm	€ 359,00
QUICK A11	W&D	1	1200 / 1400 W	22 Lt	Kit Ø 37mm	€ 331,00
QUICK A27	W&D	1	1200 / 1400 W	35 Lt	Kit Ø 40mm	€ 353,00
QUICK P30	W&D	1	1200 / 1400 W	25 Lt	Kit Ø 37mm	€ 422,00
QUICK P60	W&D	1	1200 / 1400 W	43 Lt	Kit Ø 40mm	€ 429,00
QUICK P80	W&D	1	1600 / 1800 W	80 Lt	Kit Ø 40mm	€ 606,00

## INJECTION / EXTRACTION

Multifunctional injection/extraction machines, powerful and versatile. They can be also used as wet & dry vacuum cleaners. The high capacity tanks allow a quick and continuative use.

TECHNICAL DATA				
MODEL	Type	Capacity tank	Accessories included	Price
EXTRACT P12	W&D	12 Lt	Kit Ø 37mm	€ 480,00
EXTRACT P25	W&D	25 Lt	Kit Ø 37mm	€ 497,00
EXTRACT TOP A27	W&D	25 Lt	Kit Ø 40mm	€ 455,00
EXTRACT A58.3 DP	W&D	58 Lt	Kit Ø 40mm	€ 843,00
EXTRACT A58.3	W&D	58 Lt	Kit Ø 40mm	€ 1.035,00
EXTRACT TOP CAR	W&D	58 Lt	Kit Ø 40mm	€ 795,00



Extract P12  
Extract P25

Extract A58.3 DP  
Extract A58.3  
Extract TOP CAR

## TOP P80 / P100

Special vacuum cleaners equipped with considerable robustness polyethylene tank. High resistance to chemical agents and impacts. Equipped with an extraction pump with float that can be activated by the operator or automatically when the liquid reaches a certain level. Special filter separates liquids from any solid waste. With a flow rate of 250 Lt/min it enables continuous emptying operations. Kit WET/A diam.40 included.



TECHNICAL DATA	TOP P80 WD/PE	TOP P100 WD/PE
Type	Wet	Wet
Barrel material	phed	phed
Power	230/240 V - 50/60 Hz	230/240 V - 50/60 Hz
Motor - Stages n.	1 - 2	1 - 2
Rated power	1950 W	1950 W
Vacuum - Air flow	25 kPa - 59 l/s	25 kPa - 59 l/s
Pump water flow	250 l/m	250 l/m
Total barrel capacity	80 Lt	100 Lt
Noise level	70 dB	70 dB
Price	€ 1.130,00	€ 1.190,00

# Professional Vacuum



Basic Standard P / FLY



Basic New / Plus New



Plus Silenzio



Inox



PLUS HC

**PICCOLO BASIC / BASIC NEW** Small, robust, extremely compact and silent 60 Db. **STANDARD P** Powerful (290 mBar), 61 dB. Full bag alarm, cartridge filter and additional electrical socket. **PLUS - PLUS NEW - PLUS HC** Practical accessories holder, drawer filter and the detachable cable. **SILENZIO** Equipped with power regulator to the crease the noise level. **FLY** Dedicated to the cleaning of aircraft because it directly uses the power available on aircraft (115 V, 440 Hz) without having to use external generators. **INOX** Metal flat cover and stainless steel tank, practical accessories holder, drawer filter and the detachable cable.

## TECHNICAL DATA

MODEL	Type	Motor num.	Max power	Voltage; Frequency	Capacity tank	Gross weight	Accessories included	Price
BASIC	DRY	1	800/900 W	230-240 V; 50/60 Hz	13 Lt	7 Kg	Kit Ø 32mm	€ 191,00
STANDARD P	DRY	1	800/900 W	230-240 V; 50/60 Hz	13 Lt	7 Kg	Kit Ø 37mm	€ 230,00
FLY	DRY	1	1200/1400 W	120 V; 400 Hz	13 Lt	7,5 Kg	Kit Ø 32mm	€ 278,00
BASIC NEW	DRY	1	800/900 W	230-240 V; 50/60 Hz	13 Lt	7 Kg	Kit Ø 32mm	€ 196,00
PLUS NEW	DRY	1	800/900 W	230-240 V; 50/60 Hz	13 Lt	7 Kg	Kit Ø 37mm	€ 269,00
PLUS	DRY	1	800/900 W	230-240 V; 50/60 Hz	13 Lt	7 Kg	Kit Ø 37mm	€ 247,00
SILENZIO	DRY	1	900/500 W	230-240 V; 50/60 Hz	13 Lt	7 Kg	Kit Ø 32mm	€ 292,00
INOX	DRY	1	800/900 W	230-240 V; 50/60 Hz	15 Lt	7,5 Kg	Kit Ø 32mm	€ 376,00
PLUS HC	DRY	1	800/900 W	230-240 V; 50/60 Hz	25 Lt	8 Kg	Kit Ø 37mm	€ 252,00

**DRYVER** Vacuum cleaners with excellent performances; equipped with tanks from 10 and 15 Lt. On/Off switch by foot, the teachable cable and noiseless are the main features of this product. A series of technical devices make them unique on the market, while the series filtration system returns pure air to the environment.

• Dryver "RE" Version "energy saver" mode to increase/decrease the power of the motor.



## TECHNICAL DATA

MODEL	Type	Motor num.	Max power	Voltage; Frequency	Capacity tank	Gross weight	Accessories included	Price
DRYVER 10 R	DRY	1	700/800 W	230-240 V; 50/60 Hz	10 Lt	10 Kg	Kit Ø 32mm	€ 232,00
DRYVER 10 RE	DRY	1	700/800 W	230-240 V; 50/60 Hz	10 Lt	11 Kg	Kit Ø 32mm	€ 254,00
DRYVER 15 R	DRY	1	700/800 W	230-240 V; 50/60 Hz	15 Lt	10 Kg	Kit Ø 32mm	€ 239,00
DRYVER 15 RE	DRY	1	700/800 W	230-240 V; 50/60 Hz	15 Lt	10 Kg	Kit Ø 32mm	€ 260,00

## ATOM

Practical and economic professional vacuums. High quality with removable and washable cartridge filter, protected by the entrance of the dust in order to avoid fast dogging.

**ATOM:** dry version.

**ATOM PLUS:** wet and dry version. Guarantee excellent value for money.



Atom

Atom Plus

## TECHNICAL DATA

	ATOM	ATOM PLUS
Type	Dry	Wet/Dry
Barrel material	PPL	PPL
Power	230 V / 50 Hz	230 V / 50 Hz
Motor - Stages n.	1 - 1	1 - 1
Rated power	700/900 W	1200/1350 W
Air flow (cm / h)	102	120
Total barrel capacity	10 Lt	20 Lt
Cable length	4,5 m	4,5 m
Weight	4,2 Kg	6 Kg
Price	€ 99,00	€ 102,00

# POWERVAK Boost

## INDUSTRIAL VACUUMS WITH HEPA D.O.P.14 FILTERS AND MANUAL FILTERS CLEANING

**POWERVAK BOOST 101 - 202 - 303** industrial vacuums with HEPA certification D.O.P. 14 designed to satisfy those customers looking for a competitive industrial vacuum with **compact dimensions, good suction performance and the best filtration system**. The advantages in terms of filtration and suction performance are evident, thanks to the **double filtration system** (Primary filtration with HEPA cartridge + PTFE membrane without bottom plate + Secondary Filtration Certified HEPA D.O.P. 14). With the installation of 1, 2 or 3 HEPA D.O.P. secondary filters (depending on the model) the dust filtration quality is absolute, representing an additional safety factor for the operator.

The new design of Powervak Boost, with the **motors installed in the rear, in the lower part**, has allowed us to have an industrial vacuum cleaner with reduced dimensions, with an excellent maneuverability and **easy transport**. Furthermore, the center of gravity, shifted lower, makes the industrial vacuum more stable.

- ▶ New manual Boost filter cleaning system using pressure differential designed for fine dust
- ▶ New primary Hepa cartridge filter with PTFE membrane designed without bottom plate for a perfect discharge of dust from filters and filter cleaning
- ▶ New certified secondary Hepa D.O.P. 14 filtration for highest filtration performance
- ▶ With Longopac® continuous bag dust collecting system
- ▶ Compact design for easy transport and maneuverability



**HEPA**  
filter



H CLASS CERTIFIED



*Boost 303*

*Boost 202*

*Boost 101*



MADE in ITALY



**MANUAL CLEANING**

# POWERVAK Boost 101



**FILTER SYSTEM**

Cartridge filter with an innovative design, **without lower bottom** to ensure perfect dust discharge from the filter once cleaned.



**DIFFERENTIAL PRESSURE CLEANING SYSTEM**

The filter cleaning system, defined as "differential pressure", uses a vacuum generated in the filter chamber to create a sudden jet of air in the cartridge.



**SECONDARY HEPA FILTERS**

In order to guarantee absolute filtration quality, the BOOST models are equipped with secondary HEPA filters positioned on the back of the machine.

- ▶ Compact
- ▶ Easy to Transport
- ▶ Safe
- ▶ Maneuverable

**POWERVAK Boost 101** is a compact and vertical vacuum cleaner, HEPA certified, designed to meet the customers' demand for a competitive vacuum cleaner, ensuring good suction performance, and the best possible filtration.

The renewal of the design with the installation of the motor in the lower rear part has allowed the creation of a low, compact and highly manoeuvrable aspirator for easy transport. The center of gravity, which has moved lower, has also made the extractor much more stable.



Primary filter with HEPA + PTFE filter media, useful for ensuring a smooth surface and reducing the impact of dust ▶

HEPA D.O.P. secondary filter for absolute filtering efficiency ▶

1 By-pass motor 1100W ▶

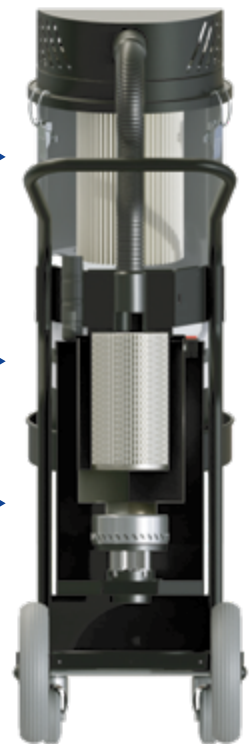

**LONGOPAC® DUST COLLECTING SYSTEM**

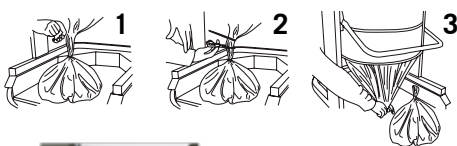

All models of the BOOST line are equipped with a Longopac continuous bag discharge system.

**TECHNICAL DATA**

Motorization	n°1 By-pass	Max Depression	230 mBar
Power	1100 W	Ø Nozzle	Tangential Ø 50 mm
Voltage	230 V	Body Diameter	Ø 330 mm
Frequency	50 / 60 Hz	Dimensions	41 x 73 x 129 cm
Amperage	4,8 A	Weight	39 Kg
Airflow	170 m³/h	Dust collecting	Longopac

**FILTERING SYSTEM**

Filter Type	Cartridge	Capacity	N°1 ULPA 15 - 9.500 cm²
Primary Filter-Surface	12.500 cm²	Filter Cleaning	Flow reversal
Filter Media	HEPA+PTFE	Price	€ 2.090,00

# POWERVAK Boost 202

MANUAL CLEANING



**FILTER SYSTEM**  
Cartridge filter with an innovative design, **without lower bottom** to ensure perfect dust discharge from the filter once cleaned.



**DIFFERENTIAL PRESSURE CLEANING SYSTEM**  
The filter cleaning system, defined as "differential pressure", uses a vacuum generated in the filter chamber to create a sudden jet of air in the cartridge.



**SECONDARY HEPA FILTERS**  
In order to guarantee absolute filtration quality, the BOOST models are equipped with secondary HEPA filters positioned on the back of the machine.

- ▶ Compact
- ▶ Easy to Transport
- ▶ Safe
- ▶ Maneuverable

**POWERVAK Boost 202** is a compact and vertical vacuum cleaner, HEPA certified, designed to meet the customers' demand for a competitive vacuum cleaner, ensuring good suction performance, and the best possible filtration.

The renewal of the design with the installation of the motor in the lower rear part has allowed the creation of a low, compact and highly manoeuvrable aspirator for easy transport. The center of gravity, which has moved lower, has also made the extractor much more stable.



**Primary filter with HEPA + PTFE filter media**, useful for ensuring a smooth surface and reducing the impact of dust ▶

**2 HEPA D.O.P. secondary filter** for absolute filtering efficiency ▶

**2 By-pass motor 2200W** ▶



### LONGOPAC® DUST COLLECTING SYSTEM

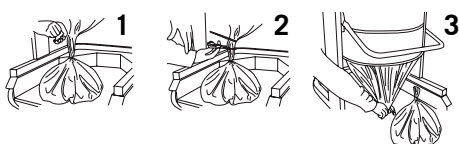

All models of the BOOST line are equipped with a Longopac continuous bag discharge system.

### TECHNICAL DATA

Motorization	n°2 By-pass	Max Depression	230 mBar
Power	2200 W	Ø Nozzle	Tangential Ø 60 mm
Voltage	230 V	Body Diameter	Ø 330 mm
Frequency	50 / 60 Hz	Dimensions	48 x 73 x 138 cm
Amperage	9,6 A	Weight	49 Kg
Airflow	340 m³/h	Dust collecting	Longopac

### FILTERING SYSTEM

Filter Type	Cartridge	Capacity	n°2 ULPA 15 - 19.000 cm²
Primary Filter-Surface	22.000 cm²	Filter Cleaning	Flow reversal
Filter Media	HEPA+2 PTFE	Price	€ 2.925,00

## MANUAL CLEANING

## POWERVAK Boost 303

**FILTER SYSTEM**

Cartridge filter with an innovative design, **without lower bottom** to ensure perfect dust discharge from the filter once cleaned.

**DIFFERENTIAL PRESSURE CLEANING SYSTEM**

The filter cleaning system, defined as "differential pressure", uses a vacuum generated in the filter chamber to create a sudden jet of air in the cartridge.

**SECONDARY HEPA FILTERS**

In order to guarantee absolute filtration quality, the BOOST models are equipped with secondary HEPA filters positioned on the back of the machine.

▶ Compact

▶ Easy to Transport

▶ Safe

▶ Maneuverable

**POWERVAK Boost 303** is a compact and vertical vacuum cleaner, HEPA certified, designed to meet the customers' demand for a competitive vacuum cleaner, ensuring good suction performance, and the best possible filtration.

The renewal of the design with the installation of the motor in the lower rear part has allowed the creation of a low, compact and highly manoeuvrable aspirator for easy transport. The center of gravity, which has moved lower, has also made the extractor much more stable.



Primary filter with HEPA + PTFE filter media, useful for ensuring a smooth surface and reducing the impact of dust ▶

3 HEPA D.O.P. secondary filter for absolute filtering efficiency ▶

3 By-passmotor 3300W ▶



## LONGOPAC® DUST COLLECTING SYSTEM

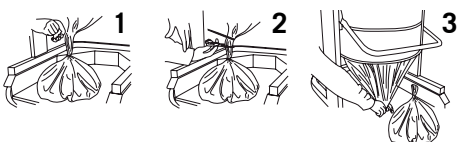

All models of the BOOST line are equipped with a Longopac continuous bag discharge system.

## TECHNICAL DATA

Motorization	n°3 By-pass	Max Depression	230 mBar
Power	3300 W	Ø Nozzle	Tangential Ø 60 mm
Voltage	230 V	Body Diameter	Ø 400 mm
Frequency	50 / 60 Hz	Dimensions	48 x 91 x 138 cm
Amperage	14,4 A	Weight	65 Kg
Airflow	510 m³/h	Dust collecting	Longopac

## FILTERING SYSTEM

Filter Type	Cartridge	Capacity	N°3 ULPA 15 - 25.500 cm²
Primary Filter-Surface	26.500 cm²	Filter Cleaning	Flow reversal
Filter Media	HEPA+3 PTFE	Price	€ 4.445,00

# POWERVAK ASC

## INDUSTRIAL VACUUMS WITH HEPA FILTERS AND ASC AUTOMATIC FILTERS SELF CLEANING

Industrial vacuum cleaners with ASC, equipped with an **automatic filter cleaning** are suitable for big quantity of concrete fine dust. Reliable and efficient, they are perfect for continuous applications without interruption even 24 hours on 24. The motor with side channel blowers provide excellent performance and can work continuously.

### ► NO-STOP ASPIRATION - Always clean filters for machines in production for no-stop applications

Thanks to this technology, the models equipped with the ASC cleaning system ensure constant suction performance by independently ensuring the cleaning of the filters without any intervention by the operator and without ever interrupting suction.

### Highest standard with filters HEPA

The safety of a dusted work environment is guaranteed by the use of HEPA filters able to filter 99.995 of dust with 0.3 granulometry.

The filter surface is also covered with a PTFE membrane that makes the surface smoother and therefore easier to clean. In addition, the PTFE membrane makes the filters waterproof.

**HEPA**  
filter



H CLASS CERTIFIED

### ASC 155 BAG



### ASC 350 BAG



### ASC 235 BAG



MADE in ITALY

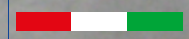

# POWERVAK ASC

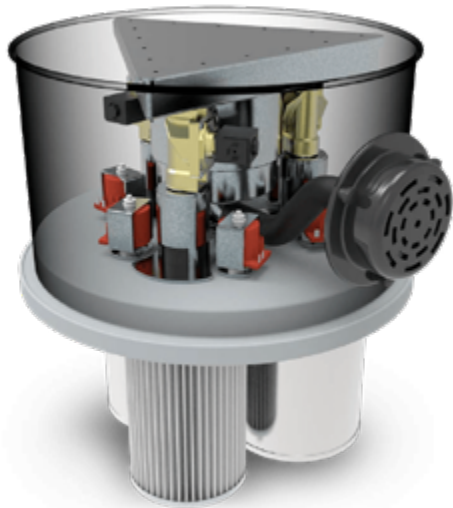

## Endless suction filters kept constantly cleaned for non-stop production machinery

Industrial vacuum cleaners with ASC suitable for grinding machines and industrial concrete floor preparation, for sucking up large quantities of fine concrete dust, without interrupting the suction. The patented ASC system ensure a constant suction performance ensuring independently the cleaning of the filters without any user intervention and without interrupting the vacuum.

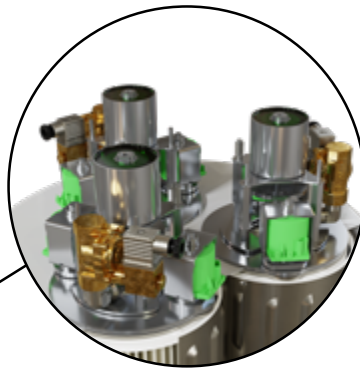
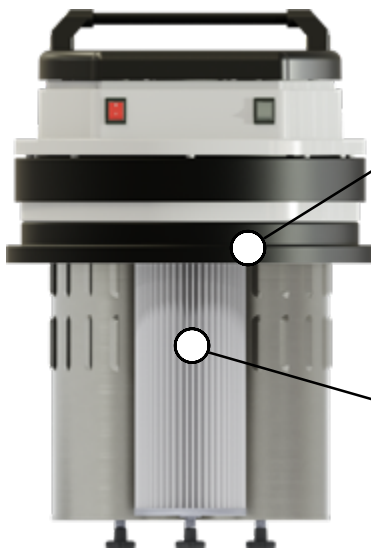

### POWERVAK ASC: HOW IT WORKS?

The industrial vacuums ASC are multi-filter vacuum cleaners. All filters work together for 2 minutes at the end of which the cyclic cleaning take place by vibrating action; the system provides the closure suction on the filter to allow the fall of the accumulated dust and the vibration of the filter. During the cyclic cleaning, the other installed filters continue to aspirate. That allow to work without interruption.

### HIGHEST STANDARD WITH FILTERS HEPA

**The safety of a dusted work environment is guaranteed by the use of HEPA filters able to filter 99.995 of dust with 0.3 granulometry.**

The filter surface is also covered with a PTFE membrane that makes the surface smoother and therefore easier to clean. In addition, the PTFE membrane makes the filters waterproof. The external part is produced using conductive material to allow the discharge of electrostatic currents during use.

### PATENTED WATERTIGHT FILTER CLEANING SYSTEM

The filters are completely closed during cleaning, which greatly increases cleaning efficiency.

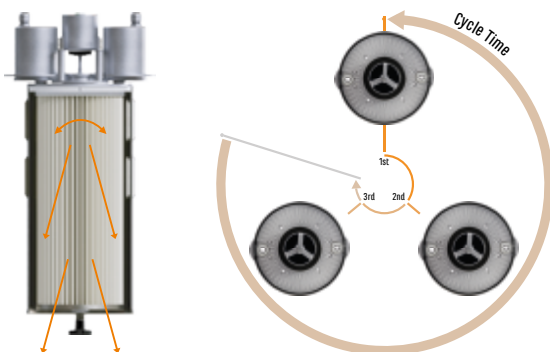

### ASC CLEANING SYSTEM

The filter cleaning cycle consists of phases in which the suction of one element is interrupted at a time. The other filtering components remain active, guaranteeing the continuity of the suction action.

### LONGOPAC® DUST COLLECTING SYSTEM

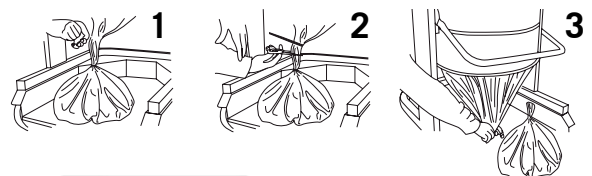

All BAGS models are equipped with a Longopac continuous bag system which allows the bagging of fine and dry dust, creating bags of variable size and weight, to be able to seal them and conveniently dispose them in absolute safety.

**WHATEVER YOUR JOB DEMANDS... WE HAVE A SOLUTION FOR YOU**



**AUTO SELF-CLEANING**

# POWERVAK ASC 220



Tangential inlet for better dust separation from the filter

Bigger rear wheels

**POWERVAK ASC 220** is the ideal partner for all professionals who require excellent suction performance and excellent filtering capabilities. A concentration of power and reliability packed into an extremely robust tool, with limited dimensions. Find its ideal application in construction employment, in bodywork or in any industry that need a practical use vacuum cleaner, good maneuverability for the suction of fine dust, whether it is connected to power tools, sanding or used as a simple tool.

Extremely compact vacuum cleaner, developed to meet the needs of the market by offering efficient suction of fine dust as well as being easy to manipulate or transportable in any location thanks to the larger posterior wheels and, at the same time, remaining a robust industrial vacuum cleaner.

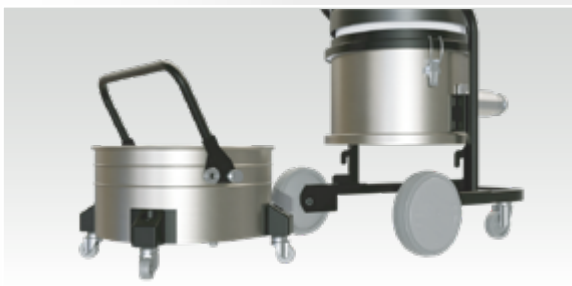
**TANK QUICK RELEASE FOR FAST DISPOSAL**

The release system for the container allows for effortless emptying of the cleaner thanks to the detachment of the vacuum head.

2 By-pass motor

Switch for forced filter cleaning

**ASC Fully automatic filter cleaning**  
Constant and endless suction  
2 HEPA Filters + PTFE Membrane

**POWERVAK ASC 220 Tool**  
Plug socket + Remote Start  
through power tools  
Max 16A

**NO-STOP ASPIRATION**

**Always clean filters for machines in production for no-stop applications.** Thanks to this technology, the models equipped with the ASC cleaning system ensure constant suction performance by independently ensuring the cleaning of the filters without any intervention by the operator and without ever interrupting suction.

**HIGHEST STANDARD with filters HEPA**

**The safety of a dusted work environment is guaranteed by the use of HEPA filters able to filter 99.995 of dust with 0.3 granulometry.** The filter surface is also covered with a PTFE membrane that makes the surface smoother and therefore easier to clean. In addition, the PTFE membrane makes the filters waterproof.

**TECHNICAL DATA**

Motorization	n°2 By-pass	Max Depression	230 mBar
Power	2200 W	Ø Nozzle	Tangential Ø 60 mm
Voltage	230 V	Tank Diameter	Ø 400 mm
Frequency	50 / 60 Hz	Dimensions	54 x 58 x 85 cm
Amperage	9,6 A	Weight	36 Kg
Airflow	340 m³/h	Capacity	Tank 20 Lt

**FILTERING SYSTEM**

Filter Type	2 x Cartridge	Filter Cleaning	Automatic
Filter-Surface	5.200 cm²	Price ASC 220	€ 1.725,00
Filter Media	HEPA+PTFE	Price ASC 220 Tool	€ 1.875,00

# POWERVAK ASC 235

**AUTO SELF-CLEANING**



Tangential inlet for better dust separation from the filter

Storage container

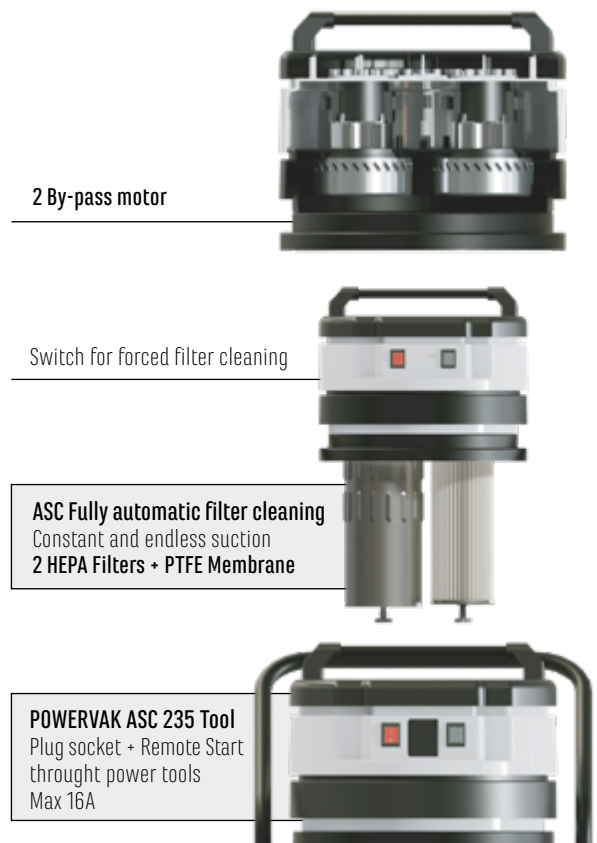

2 By-pass motor

Switch for forced filter cleaning

**ASC Fully automatic filter cleaning**  
Constant and endless suction  
2 HEPA Filters + PTFE Membrane

**POWERVAK ASC 235 Tool**  
Plug socket + Remote Start  
through power tools  
Max 16A

**POWERVAK ASC 235** increased evolution compared to the more moderate POWERVAK ASC 220 stands for more filtering capabilities and greater capacity. The reinforced trolley from the previous one allows its use in industrial environments with the most demanding applications, especially those regarding the coupling of machines that generate large amounts of dust.

Single-phase industrial vacuum cleaner with 2 collector motors, suitable for safe operation in any environment or application where there are large quantities of dust to be vacuumed thanks to the use of 2 H class filters in series and a fully automatic filter cleaning system.



**TANK QUICK RELEASE FOR FAST DISPOSAL**

The release system for the container allows for effortless emptying of the cleaner thanks to the detachment of the vacuum head.

**NO-STOP ASPIRATION**

**Always clean filters for machines in production for no-stop applications.** Thanks to this technology, the models equipped with the ASC cleaning system ensure constant suction performance by independently ensuring the cleaning of the filters without any intervention by the operator and without ever interrupting suction.

**HIGHEST STANDARD with filters HEPA**

**The safety of a dusted work environment is guaranteed by the use of HEPA filters able to filter 99.995 of dust with 0.3 granulometry.** The filter surface is also covered with a PTFE membrane that makes the surface smoother and therefore easier to clean. In addition, the PTFE membrane makes the filters waterproof.

TECHNICAL DATA			
Motorization	n°2 By-pass	Max Depression	230 mBar
Power	2200 W	Ø Nozzle	Tangential Ø 60 mm
Voltage	230 V	Tank Diameter	Ø 400 mm
Frequency	50 / 60 Hz	Dimensions	65 x 50 x 111 cm
Amperage	9,6 A	Weight	42 Kg
Airflow	340 m³/h	Capacity	Tank 35 Lt
FILTERING SYSTEM			
Filter Type	2 x Cartridge	Filter Cleaning	Automatic
Filter-Surface	8.000 cm²	Price ASC 235	€ 2.010,00
Filter Media	HEPA+PTFE	Price ASC 235 Tool	€ 2.160,00

**AUTO SELF-CLEANING**

# POWERVAK ASC 235 BAG



Tangential inlet for better dust separation from the filter

Longopac® continuous bag collecting system 22 meters

Bigger rear wheels

Storage container

**POWERVAK 235 BAG** single-phase industrial vacuum cleaner with 2 collector motors, suitable for safe operation in any environment or application where there are large quantities of dust to be vacuumed thanks to the use of 2 H class filters in series and a fully automatic filter cleaning system, ensuring effective performance and prolonged in time.

Equipped with LONGOPAC® collection system: the disposal of the vacuumed material is facilitated by the use of collection bags that, once sealed, prevent contamination of the work environment and provide additional safety for the health of the operator.

## LONGOPAC® DUST COLLECTING SYSTEM

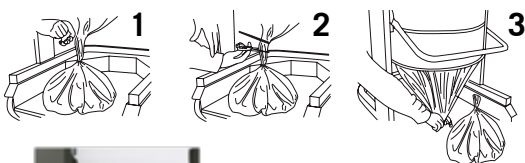

All BAGS models are equipped with a Longopac continuous bag system which allows the bagging of fine and dry dust, creating bags of variable size and weight, to be able to seal them and conveniently dispose them in absolute safety.

2 By-pass motor



Switch for forced filter cleaning



**ASC Fully automatic filter cleaning**  
Constant and endless suction  
2 HEPA Filters + PTFE Membrane

**POWERVAK ASC 235B Tool**  
Plug socket + Remote Start  
through power tools  
Max 16A



## NO-STOP ASPIRATION

**Always clean filters for machines in production for no-stop applications.** Thanks to this technology, the models equipped with the ASC cleaning system ensure constant suction performance by independently ensuring the cleaning of the filters without any intervention by the operator and without ever interrupting suction.

## HIGHEST STANDARD with filters HEPA

**The safety of a dusted work environment is guaranteed by the use of HEPA filters able to filter 99.995 of dust with 0.3 granulometry.**

### TECHNICAL DATA

Motorization	n°2 By-pass	Max Depression	230 mBar
Power	2400 W	Ø Nozzle	Tangential Ø 60 mm
Voltage	230 V	Tank Diameter	Ø 370 mm
Frequency	50 / 60 Hz	Dimensions	70 x 54 x 122 cm
Amperage	9,6 A	Weight	61 Kg
Airflow	340 m³/h	Capacity	Longopac

### FILTERING SYSTEM

Filter Type	2 x Cartridge	Filter Cleaning	Automatic
Filter-Surface	8.000 cm²	Price ASC 235 BAG	€ 2.610,00
Filter Media	HEPA+PTFE	Price ASC 235B Tool	€ 2.760,00

LONGOPAC BOX with 4 cartridge of 22meters

€ 195,00

# POWERVAK ASC 350

**AUTO SELF-CLEANING**



3 By-pass motor



Switch for forced filter cleaning



ASC Fully automatic filter cleaning  
Constant and endless suction  
3 HEPA Filters + PTFE Membrane

**POWERVAK ASC 350** model is a single-phase industrial vacuum cleaner with 3 collector motors. Model most appreciated by those who use it in daily work, especially in the field of surface treatment. The most efficient single-phase vacuum cleaner in the world for the suction of fine dust, deriving from machines in production such as sanders. Its field of application is not limited to construction, but ranges in any environment or application where there are large quantities of dust to be vacuumed thanks to the use of 3 H class filters in series and a fully automatic filter cleaning system.

## NO-STOP ASPIRATION

**Always clean filters for machines in production for no-stop applications.** Thanks to this technology, the models equipped with the ASC cleaning system ensure constant suction performance by independently ensuring the cleaning of the filters without any intervention by the operator and without ever interrupting suction.

## HIGHEST STANDARD with filters HEPA

**The safety of a dusted work environment is guaranteed by the use of HEPA filters able to filter 99.995 of dust with 0.3 granulometry.**



### TANK QUICK RELEASE FOR FAST DISPOSAL

The release system for the container allows for effortless emptying of the cleaner thanks to the detachment of the vacuum head.

### TECHNICAL DATA

Motorization	n°3 By-pass	Max Depression	510 mBar
Power	3300 W	Ø Nozzle	Tangential Ø 60 mm
Voltage	230 V	Tank Diameter	Ø 460 mm
Frequency	50 / 60 Hz	Dimensions	80 x 60 x 118 cm
Amperage	14,4 A	Weight	65 Kg
Airflow	340 m³/h	Capacity	Tank 50 Lt

### FILTERING SYSTEM

Filter Type	3 x Cartridge	Filter Cleaning	Automatic
Filter-Surface	20.500 cm²		
Filter Media	HEPA+PTFE	<b>Price ASC 350</b>	<b>€ 2.660,00</b>

**AUTO SELF-CLEANING**

# POWERVAK ASC 350 BAG



Tangential inlet for better dust separation from the filter

Longopac® continuous bag collecting system 22 meters

Storage container

Bigger rear wheels

**POWERVAK ASC 350 BAG** model is a single-phase industrial vacuum cleaner with 3 collector motors, suitable for safe operation in any environment or application where there are large quantities of dust to be vacuumed thanks to the use of 3 H class filters in series and a fully automatic filter cleaning system.

Equipped with LONGOPAC® collection system: the disposal of the vacuumed material is facilitated by the use of collection bags that, once sealed, prevent contamination of the work environment and provide additional safety for the health of the operator.

## LONGOPAC® DUST COLLECTING SYSTEM

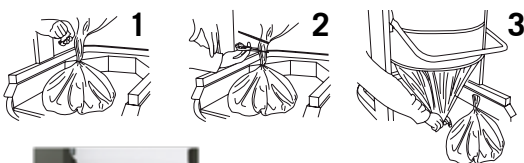

All BAGS models are equipped with a Longopac continuous bag system which allows the bagging of fine and dry dust, creating bags of variable size and weight, to be able to seal them and conveniently dispose them in absolute safety.

3 By-pass motor

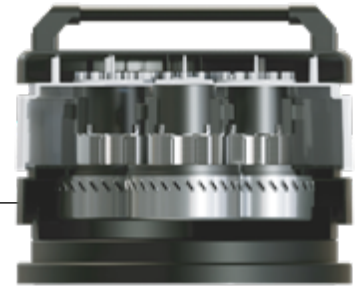

Switch for forced filter cleaning

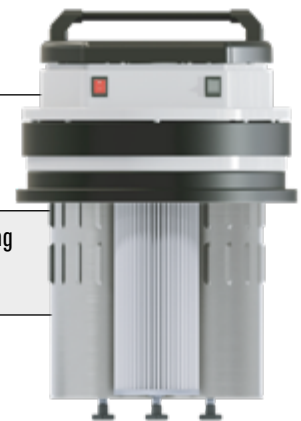

ASC Fully automatic filter cleaning  
Constant and endless suction  
3 HEPA Filters + PTFE Membrane

## NO-STOP ASPIRATION

**Always clean filters for machines in production for no-stop applications.** Thanks to this technology, the models equipped with the ASC cleaning system ensure constant suction performance by independently ensuring the cleaning of the filters without any intervention by the operator and without ever interrupting suction.

## HIGHEST STANDARD with filters HEPA

**The safety of a dusted work environment is guaranteed by the use of HEPA filters able to filter 99.995 of dust with 0.3 granulometry.**

### TECHNICAL DATA

Motorization	n°3 By-pass	Max Depression	230 mBar
Power	3600 W	Ø Nozzle	Tangential Ø 60 mm
Voltage	230 V	Tank Diameter	Ø 460 mm
Frequency	50 / 60 Hz	Dimensions	80 x 60 x 142 cm
Amperage	14,4 A	Weight	74 Kg
Airflow	510 m³/h	Capacity	Longopac

### FILTERING SYSTEM

Filter Type	3 x Cartridge	Filter Cleaning	Automatic
Filter-Surface	20.500 cm²		
Filter Media	HEPA + PTFE	Price ASC 350 BAG	€ 3.540,00

LONGOPAC BOX with 4 cartridge of 22meters

€ 195,00

# POWERVAK ASC ST

**AUTO SELF-CLEANING**



Tangential inlet for better dust separation from the filter

Storage container

Bigger rear wheels

Filter protection for improved cyclonic efficiency and protection from abrasive materials

Fully automatic filter cleaning as standard

Suction always present and efficient

3 HEPA cartridge filters + PTFE membrane for standard models

3 conductive HEPA cartridge filters for ATEX models

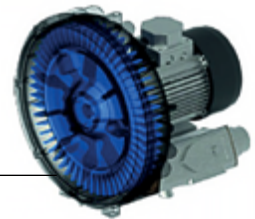
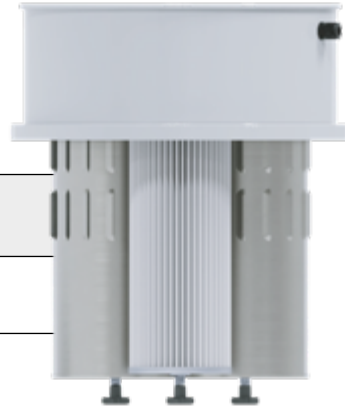

Side channel turbine  
2.2 Kw / 3Kw

The **POWERVAK ASC ST 2.2 / ST 3** models are among the only industrial vacuum cleaners on the market with side channel turbine single-stage single-phase or three-phase to boast automatic cleaning system of the filters. These vacuum cleaners have all the intrinsic benefits of the vertical design, such as reduced mobility for space in confined areas also offer the highest filtration efficiency thanks to the automatic cleaning system of filters ASC with standard HEPA filtration and absolute reliability in continuous use. Extremely sturdy, silent, powerful and reliable and suitable for continuous use 24 hours a day.



**TANK QUICK RELEASE FOR FAST DISPOSAL**

The release system for the container allows for effortless emptying of the cleaner thanks to the detachment of the vacuum head.

TECHNICAL DATA ST 2.2			
Motorization	Turbine	Max Depression	200 mBar
Power	2.2 Kw	Ø Nozzle	Tangential Ø 60 mm
Voltage	230 V	Tank Diameter	Ø 460 mm
Frequency	50 Hz	Dimensions	85 x 65 x 199 cm
Amperage	16 A	Weight	92 Kg
Airflow	320 m³/h	Capacity	Tank 100 Lt
FILTERING SYSTEM			
Filter Type	3 x Cartridge	Filter Cleaning	Automatic
Filter-Surface	21.000 cm²		
Filter Media	HEPA + PTFE	Price ASC ST2.2	€ 5.230,00

TECHNICAL DATA ST 3			
Motorization	Turbine	Max Depression	250 mBar
Power	3 Kw	Ø Nozzle	Tangential Ø 60 mm
Voltage	400 V	Tank Diameter	Ø 460 mm
Frequency	50 Hz	Dimensions	85 x 65 x 199 cm
Amperage	16 A	Weight	92 Kg
Airflow	320 m³/h	Capacity	Tank 100 Lt
FILTERING SYSTEM			
Filter Type	3 x Cartridge	Filter Cleaning	Automatic
Filter-Surface	21.000 cm²		
Filter Media	HEPA + PTFE	Price ASC ST3	€ 5.090,00

**AUTO SELF-CLEANING**

# POWERVAK ASC ST BAG



Tangential inlet for better dust separation from the filter

Longopac® continuous bag collecting system 22 meters

Storage container

Bigger rear wheels

Side channel turbine  
2.2 Kw / 3Kw

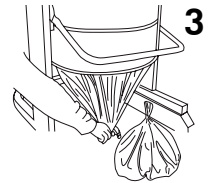
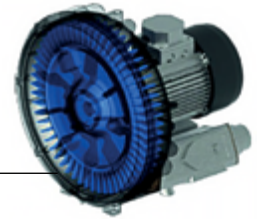

The **POWERVAK ASC ST 2.2 BAG / ST 3 BAG** models are among the only industrial vacuum cleaners on the market with side channel turbine 2.2 Kw or 3 Kw to boast automatic cleaning system of the filters.

## NO-STOP ASPIRATION

**Always clean filters for machines in production for no-stop applications.** Thanks to this technology, the models equipped with the ASC cleaning system ensure constant suction performance by independently ensuring the cleaning of the filters without any intervention by the operator and without ever interrupting suction.

## LONGOPAC® DUST COLLECTING SYSTEM

**All BAGS models are equipped with a Longopac continuous bag system** which allows the bagging of fine and dry dust, creating bags of variable size and weight, to be able to seal them and conveniently dispose them in absolute safety.

## HIGHEST STANDARD with filters HEPA

**The safety of a dusted work environment is guaranteed by the use of HEPA filters able to filter 99.995 of dust with 0.3 granulometry.**

LONGOPAC BOX with 4 cartridge of 22meters

€ 195,00

### TECHNICAL DATA ST 2.2 BAG

Motorization	Turbine	Max Depression	200 mBar
Power	2.2 Kw	Ø Nozzle	Tangential Ø 60 mm
Voltage	230 V	Tank Diameter	Ø 460 mm
Frequency	50 Hz	Dimensions	85 x 65 x 199 cm
Amperage	16 A	Weight	92 Kg
Airflow	320 m³/h	Capacity	Longopac

### FILTERING SYSTEM

Filter Type	3 x Cartridge	Filter Cleaning	Automatic
Filter-Surface	21.000 cm²		
Filter Media	HEPA + PTFE	Price ASC ST2.2 B	€ 5.865,00

### TECHNICAL DATA ST 3 BAG

Motorization	Turbine	Max Depression	250 mBar
Power	3 Kw	Ø Nozzle	Tangential Ø 60 mm
Voltage	400 V	Tank Diameter	Ø 460 mm
Frequency	50 Hz	Dimensions	85 x 65 x 199 cm
Amperage	16 A	Weight	92 Kg
Airflow	320 m³/h	Capacity	Longopac

### FILTERING SYSTEM

Filter Type	3 x Cartridge	Filter Cleaning	Automatic
Filter-Surface	21.000 cm²		
Filter Media	HEPA + PTFE	Price ASC ST3 BAG	€ 5.726,00

# POWERVAK ASC 155

**AUTO SELF-CLEANING**



Tangential inlet for better dust separation from the filter

Suction always present and efficient

**ASC Fully automatic filter cleaning**  
Constant and endless suction  
**3 HEPA Filters + PTFE Membrane**  
Filter Surface 30.000 cm<sup>2</sup>

Filter guard for improved cyclonic efficiency and protection from abrasive materials

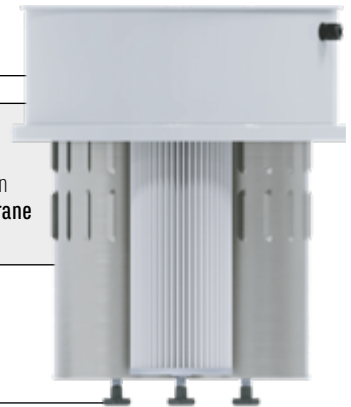

Double stage  
Side channel turbine  
3 Kw / 5.5 Kw

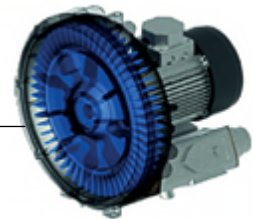

**POWERVAK ASC 155** models are among the most popular three-phase models in our range as they ensure maximum reliability and a more efficient filtering capacity thanks to the ASC automatic cleaning system of filters that never stop the intake and make it the ideal vacuum cleaner to respond to requests for continuous and prolonged aspirations over time, particularly suitable in cases of production machinery connections.



## NO-STOP ASPIRATION

**Always clean filters for machines in production for no-stop applications.** Thanks to this technology, the models equipped with the ASC cleaning system ensure constant suction performance by independently ensuring the cleaning of the filters without any intervention by the operator and without ever interrupting suction.

## HIGHEST STANDARD with filters HEPA

**The safety of a dusted work environment is guaranteed by the use of HEPA filters able to filter 99.995 of dust with 0.3 granulometry.** The filter surface is also covered with a PTFE membrane that makes the surface smoother and therefore easier to clean. In addition, the PTFE membrane makes the filters waterproof.

## TANK QUICK RELEASE FOR FAST DISPOSAL

The release system for the container allows for effortless emptying of the cleaner thanks to the detachment of the vacuum head.

	Motor	Power	Voltage/Freq	Amp	Filter Clean	Filter	Airflow	Dep. Max	Capacity	Weight	Dimension (cm)	PRICE
<b>ASC 130</b>	Turbine	3 Kw	400V / 50 Hz	6,7 A	Automatic	HEPA+PTFE	320 m <sup>3</sup> /h	320 mBar	100 Lt	150 Kg	110 x 60 x 168	<b>€ 6.485,00</b>
<b>ASC 155 P</b>	Turbine	5.5Kw	400V / 50 Hz	10,4 A	Automatic	HEPA+PTFE	520 m <sup>3</sup> /h	320 mBar	100 Lt	163 Kg	110 x 60 x 168	<b>€ 7.125,00</b>
<b>ASC 155 S</b>	Turbine	5.5Kw	400V / 50 Hz	10,4 A	Automatic	HEPA+PTFE	320 m <sup>3</sup> /h	530 mBar	100 Lt	163 Kg	110 x 60 x 168	<b>€ 7.125,00</b>

Voltage available: 220 V - 60 Hz / 480 V - 60 Hz / 575 V - 60 Hz  
Versions with filter cleaning by vibrations and blowing motor on-board

**AUTO SELF-CLEANING**

# POWERVAK ASC 155 BAG



Tangential inlet for better dust separation from the filter

Longopac® continuous bag collecting system  
22 meters

Suction always present and efficient

**ASC Fully automatic filter cleaning**  
Constant and endless suction  
**3 HEPA Filters + PTFE Membrane**  
**Filter Surface 30.000 cm<sup>2</sup>**

Filter guard for improved cyclonic efficiency and protection from abrasive materials

Double stage  
Side channel turbine  
3 Kw / 5.5 Kw

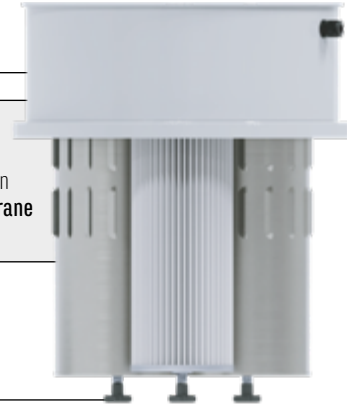

**POWERVAK ASC 155 BAG** models are among the most popular three-phase models in our range as they ensure maximum reliability and a more efficient filtering capacity thanks to the ASC automatic cleaning system of filters that never stop the intake and make it the ideal vacuum cleaner to respond to requests for continuous and prolonged aspirations over time, particularly suitable in cases of production machinery connections.

Equipped with **LONGOPAC®** collection system: the disposal of the vacuumed material is facilitated by the use of collection bags that, once sealed, prevent contamination of the work environment and provide additional safety for the health of the operator.

## HIGHEST STANDARD with filters HEPA

**The safety of a dusted work environment is guaranteed by the use of HEPA filters able to filter 99.995 of dust with 0.3 granulometry.**

## NO-STOP ASPIRATION

**Always clean filters for machines in production for no-stop applications.** Thanks to this technology, the models equipped with the ASC cleaning system ensure constant suction performance by independently ensuring the cleaning of the filters without any intervention by the operator and without ever interrupting suction.

### LONGOPAC® DUST COLLECTING SYSTEM

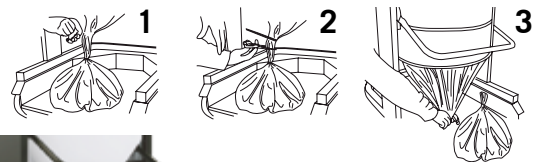

All BAGS models are equipped with a Longopac continuous bag system which allows the bagging of fine and dry dust, creating bags of variable size and weight, to be able to seal them and conveniently dispose them in absolute safety.

	Motor	Power	Voltage/Freq	Amp	Filter Clean	Filter	Airflow	Dep. Max	Capacity	Weight	Dimension (cm)	PRICE
ASC 130 BAG	Turbine	3 Kw	400V / 50 Hz	6,7 A	Automatic	HEPA+PTFE	320 m <sup>3</sup> /h	320 mBar	Longopac	150 Kg	110 x 60 x 168	€ 7.125,00
ASC 155 P BAG	Turbine	5.5Kw	400V / 50 Hz	10,4 A	Automatic	HEPA+PTFE	520 m <sup>3</sup> /h	320 mBar	Longopac	163 Kg	110 x 60 x 168	€ 7.750,00
ASC 155 S BAG	Turbine	5.5Kw	400V / 50 Hz	10,4 A	Automatic	HEPA+PTFE	320 m <sup>3</sup> /h	530 mBar	Longopac	163 Kg	110 x 60 x 168	€ 7.750,00

Voltage available: 220 V - 60 Hz / 480 V - 60 Hz / 575 V - 60 Hz  
Versions with filter cleaning by vibrations and blowing motor on-board

**LONGOPAC BOX** with 4 cartridge of 22meters

€ 195,00

# POWERVAK ASC 255

**AUTO SELF-CLEANING**



Tangential inlet for better dust separation from the filter

160 Liters Capacity Tank

Suction always present and efficient

**ASC Fully automatic filter cleaning**  
Constant and endless suction  
**5 HEPA Filters**  
+ PTFE Membrane

Filter guard for improved cyclonic efficiency and protection from abrasive materials

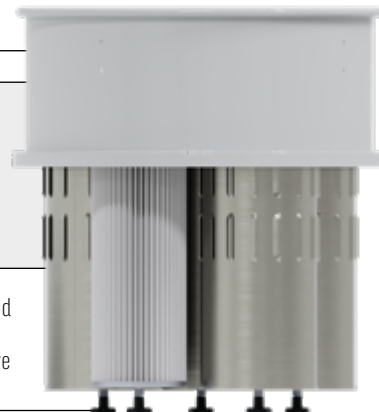

Two Double stage Side channel turbine  
2 x 5.5KW / 11 Kw

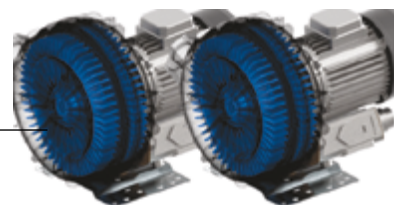

**POWERVAK ASC 255** models are extremely powerful industrial vacuum cleaners with double side channel turbine for a total of 11 kW. The more efficient filtering capacity is guaranteed by the automatic cleaning system of filters ASC that never stop the suction and make it the ideal vacuum cleaner to meet the demands of continuous and prolonged aspirations over time, particularly suitable in cases of links to machinery production or construction of centralized systems.

Voltage available: 220 V - 60 Hz / 480 V - 60 Hz / 575 V - 60 Hz  
Versions with filter cleaning by vibrations and blowing motor on-board



### TANK QUICK RELEASE FOR FAST DISPOSAL

The release system for the container allows for effortless emptying of the cleaner thanks to the detachment of the vacuum head.

#### TECHNICAL DATA ASC 255 P

Motorization	2 x Turbine	Max Depression	320 mBar
Power	11 Kw	Ø Nozzle	Tangential Ø 90 mm
Voltage	400 V	Tank Diameter	Ø 560 mm
Frequency	50 Hz	Dimensions	155 x 77 x 185 cm
Amperage	21 A	Weight	350 Kg
Airflow	1040 m³/h	Capacity	Tank 160 Lt

#### FILTERING SYSTEM

Filter Type	5 x Cartridge	Filter Cleaning	Automatic
Filter-Surface	50.000 cm²		
Filter Media	HEPA + PTFE	Price ASC 255 P	€ 14.060,00

#### TECHNICAL ASC 255 S

Motorization	2 x Turbine	Max Depression	530 mBar
Power	100 Kw	Ø Nozzle	Tangential Ø 90 mm
Voltage	400 V	Tank Diameter	Ø 560 mm
Frequency	50 Hz	Dimensions	155 x 77 x 185 cm
Amperage	21 A	Weight	350 Kg
Airflow	640 m³/h	Capacity	Tank 160 Lt

#### FILTERING SYSTEM

Filter Type	5 x Cartridge	Filter Cleaning	Automatic
Filter-Surface	50.000 cm²		
Filter Media	HEPA + PTFE	Price ASC 255 S	€ 14.060,00

**AUTO SELF-CLEANING**

# POWERVAK ASC 255 BAG



Tangential inlet for better dust separation from the filter

Longopac® continuous bag collecting system  
22 meters

Suction always present and efficient

**ASC Fully automatic filter cleaning**  
Constant and endless suction  
**5 HEPA Filters**  
+ PTFE Membrane

Filter guard for improved cyclonic efficiency and protection from abrasive materials

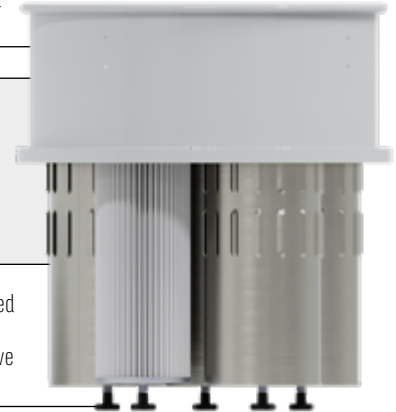

Two Double stage Side channel turbine  
2 x 5.5KW / 11 Kw

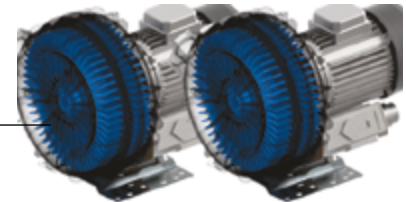

**POWERVAK ASC 255 BAG** models are extremely powerful industrial vacuum cleaners with double side channel turbine for a total of 11 kW. The more efficient filtering capacity is guaranteed by the automatic cleaning system of filters ASC that never stop the suction and make it the ideal vacuum cleaner to meet the demands of continuous and prolonged aspirations over time, particularly suitable in cases of links to machinery production or construction of centralized systems.

Equipped with **LONGOPAC®** collection system.

Voltage available: 220 V - 60 Hz / 480 V - 60 Hz / 575 V - 60 Hz  
Versions with filter cleaning by vibrations and blowing motor on-board

## LONGOPAC® DUST COLLECTING SYSTEM



All BAGS models are equipped with a Longopac continuous bag system which allows the bagging of fine and dry dust, creating bags of variable size and weight, to be able to seal them and conveniently dispose them in absolute safety.

LONGOPAC BOX with 4 cartridge of 22meters

€ 195,00

### TECHNICAL DATA ASC 255 P BAG

Motorization	2 x Turbine	Max Depression	320 mBar
Power	11 Kw	Ø Nozzle	Tangential Ø 90 mm
Voltage	400 V	Tank Diameter	Ø 560 mm
Frequency	50 Hz	Dimensions	155 x 77 x 185 cm
Amperage	21 A	Weight	350 Kg
Airflow	1040 m³/h	Capacity	Longopac

### FILTERING SYSTEM

Filter Type	5 x Cartridge	Filter Cleaning	Automatic
Filter-Surface	50.000 cm²		
Filter Media	HEPA + PTFE	Price 255 P BAG	€ 14.850,00

### TECHNICAL DATA ASC 255 S BAG

Motorization	2 x Turbine	Max Depression	530 mBar
Power	11 Kw	Ø Nozzle	Tangential Ø 90 mm
Voltage	400 V	Tank Diameter	Ø 560 mm
Frequency	50 Hz	Dimensions	155 x 77 x 185 cm
Amperage	21 A	Weight	350 Kg
Airflow	640 m³/h	Capacity	Longopac

### FILTERING SYSTEM

Filter Type	5 x Cartridge	Filter Cleaning	Automatic
Filter-Surface	50.000 cm²		
Filter Media	HEPA + PTFE	Price 255 S BAG	€ 14.850,00

# POWERVAK Base

## INDUSTRIAL VACUUMS GENERIC ALL-PURPOSE AND MODULAR

The range of industrial vacuum cleaners of the Base line is built with the classical and conventional filter systems known on the market; polyester fabric filters / nonwoven defined in pockets or stellar. Base line is suitable for multiple generic applications, but at the same time has the disadvantage of having little specific machines, especially in the case of intake of complex powders such as fine powders.

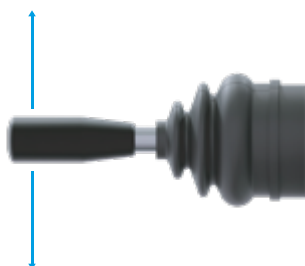

Manual shaking filter cleaning system



Pocket filter available in different size and materials



Secondary HEPA filter optional

### ► SUCTION OF DUST AND LIQUIDS (MODEL W)

Thanks to the deflector it directs the liquid flow downwards avoiding wetting the filter. To have a multipurpose vacuum cleaner, that is, suitable for the aspiration of any kind of material, dry or liquid, the choice of the type of nozzle prefers the central type inlet. This thanks to the deflector directs the flow of liquid downwards, avoiding wetting the filter. As for the suction of dust, it proves less effective than the tangential inlet as the deflector significantly slows down the flow of dust, which is more easily attracted to the filter.

A Wet & Dry (WD) multipurpose vacuum cleaner can have its inlet mounted centrally or laterally. A central inlet is preferable in case of liquids, as the deflector directs liquid downwards hence avoiding wetting the filter. A lateral inlet is preferable in case of dry materials as it helps with flowing of the material thanks to a better cyclonic effect. With Klinsystem you can choose both.

### ► ONLY DUST SUCTION (MODEL B)

The speed of the air and the entry into the container drum is higher than conventional central unions, favoring the cyclonic effect. The best configuration for dust extraction is the installation of the tangential type nozzle, as the speed of the air and the entry into the container drum is higher than conventional central nozzles favoring the cyclonic effect, therefore greater separation of the dust from the filter.



MADE in ITALY

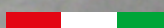

**MANUAL CLEANING**

# POWERVAK Base WM 250



Manual filter  
Cleaning device

Central inlet for  
simultaneous suction  
of dust, solids and liquids

Bigger rear  
wheels

**POWERVAK BASE WM 250** is the most classic and common single-phase industrial vacuum cleaner. 2 by-pass motors, 50 liters capacity, steel drums and conventional filtration in pockets or star filter. This model responds to multiple non-specific applications in the industrial field.



**TANK QUICK RELEASE FOR FAST DISPOSAL**

The release system for the container allows for effortless emptying of the cleaner thanks to the detachment of the vacuum head.

2 By-pass motors



Filtration Class L / M  
13.000 cm<sup>2</sup>



**OPTIONAL**  
secondary HEPA filter  
€ 175,00



**FILTERING SYSTEM**

This series of BASE industrial vacuum cleaners refers to the more classic and simple filtration system normally used by most common industrial vacuum cleaners with filters made of polyester fabric / non-woven fabric with pockets or star shaped filters offering standard filtration of 3 μ particles that can be increased by using optional filters with PTFE membrane for 1 μ particles.

**FILTERING SYSTEM WM250 L**

Filter Type	Stellar polyester
Filter-Surface	13.000 cm <sup>2</sup>
Filter Media	L
Filter Cleaning	Manual shaking

**FILTERING SYSTEM WM250 M**

Filter Type	Stellar polyester
Filter-Surface	13.000 cm <sup>2</sup>
Filter Media	M
Filter Cleaning	Manual shaking

	Motor	Power	Voltage/Freq	Amp	Airflow	Dep. Max	Capacity	Weight	Dimension (cm)	Ø Nozzle	PRICE
<b>WM 250 L</b>	2 By-pass	2200W	230V/50-60Hz	9,6 A	340 m <sup>3</sup> /h	230 mBar	50 Lt	36 Kg	54 x 58 x 135	Central Ø 70 mm	<b>€ 1.365,00</b>
<b>WM 250 M</b>	2 By-pass	2200W	230V/50-60Hz	9,6 A	340 m <sup>3</sup> /h	230 mBar	50 Lt	36 Kg	54 x 58 x 135	Central Ø 70 mm	<b>€ 1.455,00</b>
<b>WM 250 L Tool</b>	2 By-pass	2200W	230V/50-60Hz	9,6 A	340 m <sup>3</sup> /h	230 mBar	50 Lt	36 Kg	54 x 58 x 135	Central Ø 70 mm	<b>€ 1.515,00</b>
<b>WM 250 M Tool</b>	2 By-pass	2200W	230V/50-60Hz	9,6 A	340 m <sup>3</sup> /h	230 mBar	50 Lt	36 Kg	54 x 58 x 135	Central Ø 70 mm	<b>€ 1.605,00</b>

# POWERVAK Base BM 375

**MANUAL CLEANING**



3 By-pass motors



Filtration Class L / M  
20.000 / 30.000 cm<sup>2</sup>



OPTIONAL  
secondary HEPA filter  
€ 220,00



**POWERVAK BASE BM 375** is the most classic and common single-phase industrial vacuum cleaner. 3 by-pass motors and conventional filtration in pockets or star filter. Its maneuverability, combined with the compact design, allows it to be easily moved, even in the most confined spaces, facilitating routine cleaning of your machinery. Ideal for several applications not specific in the industrial field and in cases where there are no problems regarding large amounts of dust, especially the grainy one.



### TANK QUICK RELEASE FOR FAST DISPOSAL

The release system for the container allows for effortless emptying of the cleaner thanks to the detachment of the vacuum head.

Available also model **POWERVAK BASE 375 WM** for simultaneous suction of dust, solids and liquids with central inlet. The deflector directs liquid downwards hence avoiding wetting the filter.

### TECHNICAL DATA BM 375 L

Motorization	n°3 By-pass	Max Depression	230 mBar
Power	3300 W	Ø Nozzle	Tangential Ø 60 mm
Voltage	230 V	Tank Diameter	Ø 460 mm
Frequency	50 / 60 Hz	Dimensions	80 x 60 x 152 cm
Amperage	14,4 A	Weight	62 Kg
Airflow	510 m <sup>3</sup> /h	Capacity	Tank 75 Lt

### FILTERING SYSTEM

Filter Type	Stellar polyester	Filter Cleaning	Manual Shaking
Filter-Surface	20.000 cm <sup>2</sup>		
Filter Media	L	<b>Price BM 375 L</b>	<b>€ 1.955,00</b>

FILTRATION OPTIONS	Filtering Surface	Filtration	PRICE	FILTRATION OPTIONS	Filtering Surface	Filtration	PRICE
M Class Filter	20.000 cm <sup>2</sup>	M	€ 112,00	Nomex filter High Temperature 200/220 C°	20.000 cm <sup>2</sup>	M	€ 182,00
M Class Filter + Antistatic	20.000 cm <sup>2</sup>	M	€ 180,00	L Class Filter	30.000 cm <sup>2</sup>	L	€ 95,00
M Class Filter + PTFE	20.000 cm <sup>2</sup>	M	€ 231,00	M Class Filter	30.000 cm <sup>2</sup>	M	€ 215,00

**MANUAL CLEANING**

# POWERVAK Base BM 3100



3 By-pass motors



Filtration Class L / M  
20.000 / 30.000 cm<sup>2</sup>



OPTIONAL  
secondary HEPA filter  
€ 220,00



**POWERVAK BASE BM 3100** is a BASE BM 375 direct derivation vacuum cleaner, strengthened with a new trolley and with features of great versatility and ease of use.

Available also model **POWERVAK BASE WM 3100** for simultaneous suction of dust, solids and liquids with central inlet. The deflector directs liquid downwards hence avoiding wetting the filter.



**TANK QUICK RELEASE FOR FAST DISPOSAL**

**LONGOPAC® DUST COLLECTING SYSTEM**

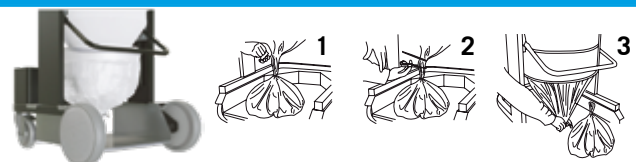

POWERVAK BASE BT 3100 BAG models are equipped with a Longopac continuous bag system which allows the bagging of fine and dry dust, creating bags of variable size and weight, to be able to seal them and conveniently dispose them in absolute safety.

LONGOPAC BOX with 4 cartridge of 22meters

€ 195,00

**FILTERING SYSTEM**

Filter Type	Stellar polyester	Filter Media	L
Filter-Surface	20.000 cm <sup>2</sup>	Filter Cleaning	Manual shaking

	Motor	Power	Voltage/Freq	Amp	Airflow	Dep. Max	Capacity	Weight	Dimension (cm)	Ø Nozzle	PRICE
<b>BM 3100 L</b>	3 By-pass	3300W	230V/50-60Hz	14,4 A	510 m <sup>3</sup> /h	230 mBar	100 Lt	80 Kg	54 x 58 x 135	Tangential Ø 60 mm	€ 2.215,00
<b>BM 3100 L BAG</b>	3 By-pass	3300W	230V/50-60Hz	14,4 A	510 m <sup>3</sup> /h	230 mBar	Longopac	80 Kg	54 x 58 x 135	Tangential Ø 60 mm	€ 2.850,00

FILTRATION OPTIONS	Filtering Surface	Filtration	PRICE	FILTRATION OPTIONS	Filtering Surface	Filtration	PRICE
M Class Filter	20.000 cm <sup>3</sup>	M	€ 112,00	Nomex filter High Temperature 200/220 C°	20.000 cm <sup>3</sup>	M	€ 182,00
M Class Filter + Antistatic	20.000 cm <sup>3</sup>	M	€ 180,00	L Class Filter	30.000 cm <sup>3</sup>	L	€ 95,00
M Class Filter + PTFE	20.000 cm <sup>3</sup>	M	€ 231,00	M Class Filter	30.000 cm <sup>3</sup>	M	€ 215,00

# POWERVAK Base BT 751

**MANUAL CLEANING**

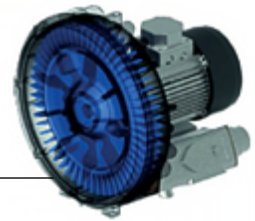

Side channel turbine  
2.2 Kw / 3Kw



Filtration Class L / M  
22.000 / 30.000 cm<sup>2</sup>



OPTIONAL  
secondary HEPA filter  
€ 220,00

**POWERVAK BASE BT 751** models are the most popular turbine models as they enjoy excellent reliability thanks to the side channel turbine and are multipurpose for suction of any kind of debris but not recommended for fine dust. Their simplicity and veracity make them among the most popular models on the market.

TECHNICAL BT 751 L			
Motorization	Turbine	Max Depression	200 mBar
Power	2.2 Kw	Ø Nozzle	Tangential Ø 60 mm
Voltage	230 V	Tank Diameter	Ø 460 mm
Frequency	50 Hz	Dimensions	80 x 63 x 165 cm
Amperage	16 A	Weight	100 Kg
Airflow	320 m <sup>3</sup> /h	Capacity	Tank 75 Lt
FILTERING SYSTEM			
Filter Type	Stellar polyester	Filter Cleaning	Manual Shaking
Filter-Surface	22.000 cm <sup>2</sup>		
Filter Media	L	Price BT 751 L	€ 2.785,00

TECHNICAL DATA BT 753 L			
Motorization	Turbine	Max Depression	250 mBar
Power	3 Kw	Ø Nozzle	Tangential Ø 60 mm
Voltage	400 V	Tank Diameter	Ø 460 mm
Frequency	50 / 60 Hz	Dimensions	80 x 63 x 165 cm
Amperage	6,7 A	Weight	100 Kg
Airflow	320 m <sup>3</sup> /h	Capacity	Tank 75 Lt
FILTERING SYSTEM			
Filter Type	Stellar polyester	Filter Cleaning	Manual Shaking
Filter-Surface	22.000 cm <sup>2</sup>		
Filter Media	L	Price BT 753 L	€ 2.645,00

FILTRATION OPTIONS	Filtering Surface	Filtration	PRICE
M Class Filter	20.000 cm <sup>3</sup>	M	€ 112,00
M Class Filter + Antistatic	20.000 cm <sup>3</sup>	M	€ 180,00
M Class Filter + PTFE	20.000 cm <sup>3</sup>	M	€ 231,00

FILTRATION OPTIONS	Filtering Surface	Filtration	PRICE
Nomex Filter High Temperature 200/220 C°	20.000 cm <sup>3</sup>	M	€ 182,00
L Class Filter	30.000 cm <sup>3</sup>	L	€ 95,00
M Class Filter	30.000 cm <sup>3</sup>	M	€ 215,00

**MANUAL CLEANING**

# POWERVAK Base BT 722

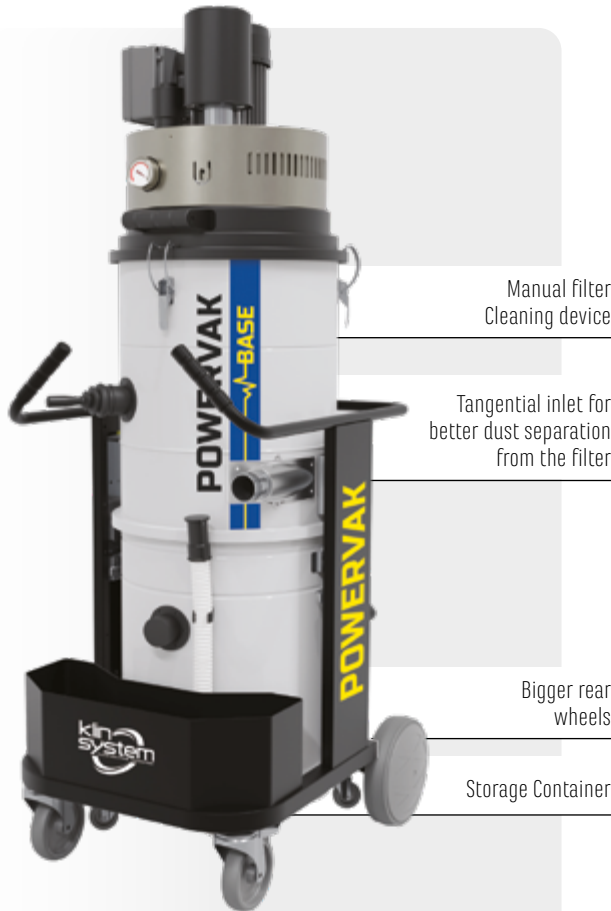

Manual filter  
Cleaning device

Tangential inlet for  
better dust separation  
from the filter

Bigger rear  
wheels

Storage Container

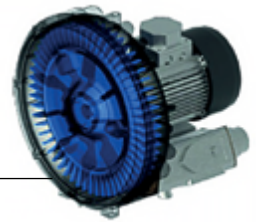

Side channel turbine  
2.2 Kw / 3Kw



Filtration Class L / M  
22.000 / 30.000 cm<sup>2</sup>



**OPTIONAL**  
secondary HEPA filter  
€ 220,00

**POWERVAK BASE BT 722 - 730** are among the most popular turbine models on the market of industrial vacuum cleaners as they have excellent reliability thanks to the side channel turbine and have the ability to be multipurpose for the suction of any kind of debris, whether dusty, solid or liquid.



**TANK QUICK RELEASE FOR FAST DISPOSAL**

**LONGOPAC® DUST COLLECTING SYSTEM**

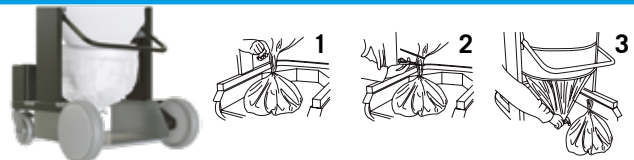

**BASE BT 722 / BT 730 BAG models are equipped with a Longopac continuous bag system** which allows the bagging of fine and dry dust, creating bags of variable size and weight, to be able to seal them and conveniently dispose them in absolute safety.

**LONGOPAC BOX** with 4 cartridge of 22meters

**€ 195,00**

**FILTERING SYSTEM**

Filter Type	<b>Stellar polyester</b>	Filter Media	<b>L</b>
Filter-Surface	<b>22.000 cm<sup>2</sup></b>	Filter Cleaning	<b>Manual shaking</b>

	Motor	Power	Voltage/Freq	Amp	Airflow	Dep. Max	Capacity	Weight	Dimension (cm)	Ø Nozzle	PRICE
<b>BT 722 BL</b>	Turbine	2.2 Kw	230V/50 Hz	16 A	320 m <sup>3</sup> /h	200 mBar	100 Lt	92 Kg	85 x 65 x 199	Tangential Ø 60mm	<b>€ 2.995,00</b>
<b>BT 730 BL</b>	Turbine	3 Kw	400V/50-60Hz	6,7 A	320 m <sup>3</sup> /h	250 mBar	100 Lt	92 Kg	85 x 65 x 199	Tangential Ø 60mm	<b>€ 2.855,00</b>
<b>BT 722 BL BAG</b>	Turbine	2.2 Kw	230V/50 Hz	16 A	320 m <sup>3</sup> /h	200 mBar	Longopac	92 Kg	85 x 65 x 199	Tangential Ø 60mm	<b>€ 3.635,00</b>
<b>BT 730 BL BAG</b>	Turbine	3 Kw	400V/50-60Hz	6,7 A	320 m <sup>3</sup> /h	250 mBar	Longopac	92 Kg	85 x 65 x 199	Tangential Ø 60mm	<b>€ 3.495,00</b>

<b>FILTRATION OPTIONS</b>	Filtering Surface	Filtration	PRICE	<b>FILTRATION OPTIONS</b>	Filtering Surface	Filtration	PRICE
<b>M Class Filter</b>	20.000 cm <sup>3</sup>	M	<b>€ 112,00</b>	<b>Nomex filter High Temperature 200/220 C°</b>	20.000 cm <sup>3</sup>	M	<b>€ 182,00</b>
<b>M Class Filter + Antistatic</b>	20.000 cm <sup>3</sup>	M	<b>€ 180,00</b>	<b>L Class Filter</b>	30.000 cm <sup>3</sup>	L	<b>€ 95,00</b>
<b>M Class Filter + PTFE</b>	20.000 cm <sup>3</sup>	M	<b>€ 231,00</b>	<b>M Class Filter</b>	30.000 cm <sup>3</sup>	M	<b>€ 215,00</b>

# POWERVAK Base BT 155

**MANUAL CLEANING**



Manual filter  
Cleaning device

Tangential inlet for  
better dust separation  
from the filter

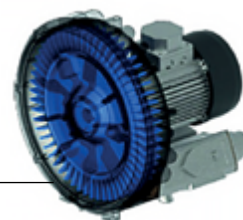

Double stage Side  
channel turbine  
5.5 Kw



Filtration Class L / M  
20.000 / 30.000 cm<sup>2</sup>



OPTIONAL  
secondary HEPA filter  
€ 220,00

**POWERVAK BASE BT 155 P / S** is the industrial vacuum cleaner that combines power and reliability, motorized with 5,5 kW three-phase side channel turbine. Designed and built for constant and continuous use is critical for companies that need a good suction power for vacuuming non-specific dust or debris that can be fine dust.



**TANK QUICK RELEASE FOR FAST DISPOSAL**

The release system for the container allows for effortless emptying of the cleaner thanks to the detachment of the vacuum head.

**LONGOPAC® DUST COLLECTING SYSTEM**

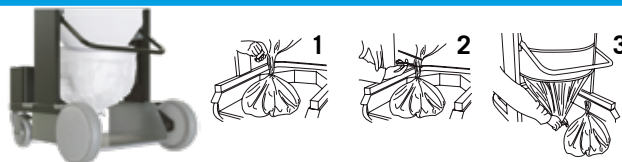

POWERVAK BASE BT 155 P/S BAG models are equipped with a Longopac continuous bag system which allows the bagging of fine and dry dust, creating bags of variable size and weight, to be able to seal them and conveniently dispose them in absolute safety.

LONGOPAC BOX with 4 cartridge of 22meters

€ 195,00

**FILTERING SYSTEM**

Filter Type	Stellar polyester	Filter Media	L
Filter-Surface	20.000 cm <sup>2</sup>	Filter Cleaning	Manual shaking

	Motor	Power	Voltage/Freq	Amp	Airflow	Dep. Max	Capacity	Weight	Dimension (cm)	Ø Nozzle	PRICE
BT155 L-P	Turbine	5.5 Kw	400V/50 Hz	10,4 A	520 m <sup>3</sup> /h	320 mBar	100 Lt	150 Kg	100 x 60 x 140	Tangential Ø 60mm	€ 4.185,00
BT155 L-S	Turbine	5.5 Kw	400V/50-60Hz	10,4 A	320 m <sup>3</sup> /h	530 mBar	100 Lt	150 Kg	100 x 60 x 140	Tangential Ø 60mm	€ 4.185,00
BT155 L-P BAG	Turbine	5.5 Kw	400V/50 Hz	10,4 A	520 m <sup>3</sup> /h	320 mBar	Longopac	150 Kg	100 x 60 x 140	Tangential Ø 60mm	€ 4.820,00
BT155 L-S BAG	Turbine	5.5 Kw	400V/50-60Hz	10,4 A	320 m <sup>3</sup> /h	530 mBar	Longopac	150 Kg	100 x 60 x 140	Tangential Ø 60mm	€ 4.820,00

FILTRATION OPTIONS	Filtering Surface	Filtration	PRICE	FILTRATION OPTIONS	Filtering Surface	Filtration	PRICE
M Class Filter	20.000 cm <sup>3</sup>	M	€ 112,00	Nomex filter High Temperature 200/220 C°	20.000 cm <sup>3</sup>	M	€ 182,00
M Class Filter + Antistatic	20.000 cm <sup>3</sup>	M	€ 180,00	L Class Filter	30.000 cm <sup>3</sup>	L	€ 95,00
M Class Filter + PTFE	20.000 cm <sup>3</sup>	M	€ 231,00	M Class Filter	30.000 cm <sup>3</sup>	M	€ 215,00

**MANUAL CLEANING**

# POWERVAK Base BT 255



Manual filter  
Cleaning device

Tangential inlet for  
better dust separation  
from the filter

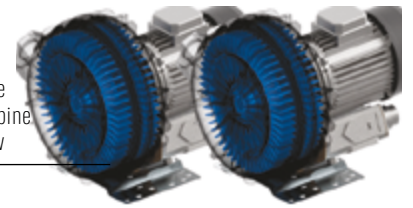

Two Double stage  
Side channel turbine  
2 x 5.5KW / 11 Kw



Filtration Class L / M  
50.000 cm<sup>2</sup>



OPTIONAL  
secondary HEPA filter  
€ 986,00

**POWERVAK BASE BT 255** is an extremely powerful industrial vacuum cleaners with double side channel turbine for a total of 11 kW, with manual shaking cleaning system. Can be used in heavy duty applications, or for centralised systems. Also, optional, with automatic Filter Cleaning System



**TANK QUICK RELEASE FOR FAST DISPOSAL**

The release system for the container allows for effortless emptying of the cleaner thanks to the detachment of the vacuum head.

**LONGOPAC® DUST COLLECTING SYSTEM**

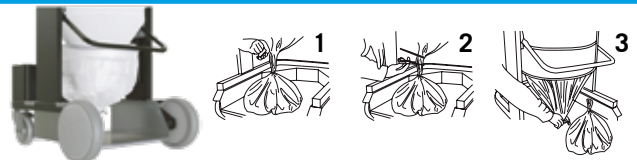

**POWERVAK BASE BT 255 BAG models** are equipped with a Longopac continuous bag system which allows the bagging of fine and dry dust, creating bags of variable size and weight, to be able to seal them and conveniently dispose them in absolute safety.

LONGOPAC BOX with 4 cartridge of 22meters

€ 195,00

**TECHNICAL DATA BT 255 / BT 255 BAG**

Motorization	2 x Turbine	Max Depression	320 mBar
Power	11 Kw	Ø Nozzle	Tangential Ø 90 mm
Voltage	400 V	Tank Diameter	Ø 560 mm
Frequency	50 Hz	Dimensions	150 x 78 x 174 cm
Amperage	21 A	Weight	150 Kg
Airflow	1040 m <sup>3</sup> /h	Capacity	Tank 160 Lt / Longopac

**FILTERING SYSTEM**

Filter Type	Stellar polyester	Filter Cleaning	Manual Shaking
Filter-Surface	50.000 cm <sup>2</sup>	Price BT 111 P	€ 12.065,00
Filter Media	L	Price BT 111 P BAG	€ 12.855,00

**FILTRATION OPTIONS**

Filtration Options	Filtering Surface	Filtration	PRICE
M Class Filter	50.000 cm <sup>2</sup>	M	€ 250,00
M Class Filter + Antistatic	50.000 cm <sup>2</sup>	M	€ 285,00
M Class Filter + PTFE	50.000 cm <sup>2</sup>	M	€ 369,00



## ONE



**THE VACUUM ONE** models represent the best choice compared to the conventional self-service vacuums thanks to the superior engineering design thus offering advantages in terms of suction efficiency and ergonomical features for the machine management.

### FILTERING SYSTEM

The filter is polyester made with conical shape. The accessibility to the filter is easy and free of containment vacuumed material thanks to the scroll guides placed on the top of the machine. The tangential inlet is on standard, in order to prevent long bodies from getting stuck at the vacuum inlet, increasing moreover the cyclone effect of debris.

### SMART AND HEALTHY DEBRIS DISPOSAL SYSTEM

The quick tank release with wheels is useful to car-wash station's owner when the vacuum must be emptied, avoiding to take the cover and conventional filters out ensuring a dust-free and comfortable maintenance.

### AUTOMATIC FILTER CLEANING

Once the credit is over the vacuum turn off and a weight inside the filter fall down shaking it.

OPTIONALS	DESCRIPTION	PRICE
KACSELF	Compressed air Kit	€ 255,00
7546SF	Blowing Kit	€ 690,00
COUNTER	Electromechanic counter	€ 60,00

MODEL	Motorization	Body	Voltage / Freq.	Filter	Filter Shaker	Air flow	Max dep.	Cap.	Coin acceptor	Size (cm)	PRICE
ONE 3 PH - Mec	Turbine 2,2 Kw	Stainless Steel Aisi 304	400V / 50Hz	Polyester 4.000cm <sup>2</sup>	Automatic	320 m <sup>3</sup> /h	320 mBar	50 Lt	Mechanical	90x65x160	€ 3.725,00
ONE 3 PH - Ele	Turbine 2,2 Kw	Stainless Steel Aisi 304	400V / 50Hz	Polyester 4.000cm <sup>2</sup>	Automatic	320 m <sup>3</sup> /h	320 mBar	50 Lt	Electronic	90x65x160	€ 4.015,00

Also available version Turbine 2,2 kW - 230 V (mechanical or electronic)

## EVO



**EVO INNOVATIVE SELF-SERVICE VACUUMS** are designed following industrial vacuum's standards offering advantages in terms of suction efficiency and reduced filter clogging. The maintenance of filters is absolutely limited compared to the conventional self-service vacuums, thanks to the Klinsystem industrial vacuums filtration technology and filters cleaning allowing an almost free-maintenance to the vacuum. These great advantages bring benefits to the customer's satisfaction in terms of performances and consequently to the car wash station's owner limiting his contact with hazardous dusts, especially when the container must be emptied or a standard filter must be frequently cleaned.

### FILTERING SYSTEM

The aluminized Class M cartridge filter is conductive, ensuring the discharge of static electricity and protected by a special Patented cyclone made of stainless steel. The tangential inlet is on standard, in order to prevent long bodies from getting stuck at the vacuum inlet, increasing moreover the cyclone effect of debris. The filter protection is made to reduce the filter clogging and to ensure that the filter remains Dry even if customers would like to collect few quantities of liquids.

### SMART AND HEALTHY DEBRIS DISPOSAL SYSTEM

The quick tank release with wheels is useful to car-wash station's owner when the vacuum must be emptied, avoiding to take the cover and conventional filters out ensuring a dust-free and comfortable maintenance.

OPTIONALS	DESCRIPTION	PRICE
KACSELF	Compressed air Kit	€ 255,00
7546SF	Blowing Kit	€ 690,00
SAFE	Safe collection of maney or token with lock	€ 60,00
COUNTER	Electromechanic counter	€ 60,00

MODEL	Motorization	Body	Voltage / Freq.	Filter	Filter Shaker	Air flow	Max dep.	Cap.	Coin acceptor	Size (cm)	PRICE
EVO 3 PH - Mec	Turbine 2,2 Kw	Stainless Steel Aisi 304	400V / 50Hz	Cartrige 13.000cm <sup>2</sup>	Manual	320 m <sup>3</sup> /h	320 mBar	50 Lt	Mechanical	90x65x160	€ 3.990,00
EVO 3 PH - Ele	Turbine 2,2 Kw	Stainless Steel Aisi 304	400V / 50Hz	Cartrige 13.000cm <sup>2</sup>	Manual	320 m <sup>3</sup> /h	320 mBar	50 Lt	Electronic	90x65x160	€ 4.280,00

Also available version Turbine 2,2 kW - 230 V (mechanical or electronic)

MADE in ITALY

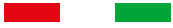

# CAR WASH INDUSTRIAL VACUUMS

## SHAKE



**SHAKE INNOVATIVE SELF-SERVICE VACUUMS** are designed following industrial vacuum's standards offering advantages in terms of suction efficiency and reduced filter clogging. The maintenance of filters is absolutely limited compared to the conventional self-service vacuums, thanks to the Klinsystem industrial vacuums filtration technology and filters cleaning allowing an almost free-maintenance to the vacuum. These great advantages bring benefits to the customer's satisfaction in terms of performances and consequently to the car wash station's owner limiting his contact with hazardous dusts, especially when the container must be emptied or a standard filter must be frequently cleaned.

### FILTERING SYSTEM

The aluminized Class M cartridge filter is conductive, ensuring the discharge of static electricity and protected by a special Patented cyclone made of stainless steel. The tangential inlet is on standard, in order to prevent long bodies from getting stuck at the vacuum inlet, increasing moreover the cyclone effect of debris. The filter protection is made to reduce the filter clogging and to ensure that the filter remains Dry even if customers would like to collect few quantities of liquids.

### PATENTED SEMI-AUTOMATIC FILTER SHAKER

The filter shaker is formed by a mechanical-pneumatic piston, which, by moving up and down, violently hits the bottom of the filter thus creating the vibrations required for perfect cleaning and also reducing operation time. This function is performed automatically by moving a lever on the machine.

### SMART AND HEALTHY DEBRIS DISPOSAL SYSTEM







The quick tank release with wheels is useful to car-wash station's owner when the vacuum must be emptied, avoiding to take the cover and conventional filters out ensuring a dust-free and comfortable maintenance.

OPTIONALS	DESCRIPTION	PRICE
KACSELF	Compressed air Kit	€ 255,00
7546SF	Blowing Kit	€ 690,00
SAFE	Safe collection of maney or token with lock	€ 60,00
COUNTER	Electromechanic counter	€ 60,00





MODEL	Motorization	Body	Voltage / Freq.	Filter	Filter Shaker	Air flow	Max dep.	Cap.	Coin acceptor	Size (cm)	PRICE
SHAKE 3 PH-Mec	Turbine 2,2 Kw	Stainless Steel Aisi 304	400V / 50Hz	Cartrige 13.000cm <sup>2</sup>	Semi-Auto	320 m <sup>3</sup> /h	320 mBar	50 Lt	Mechanical	90x65x160	€ 4.715,00
SHAKE 3 PH-Ele	Turbine 2,2 Kw	Stainless Steel Aisi 304	400V / 50Hz	Cartrige 13.000cm <sup>2</sup>	Semi-Auto	320 m <sup>3</sup> /h	320 mBar	50 Lt	Electronic	90x65x160	€ 5.005,00

Also available version Turbine 2,2 kW - 230 V (mechanical or electronic)

# KIT ACCESSORIES

	<b>CODE</b> KIT10M.50	<b>Kit for general cleaning on models which can fit the 60-50 intel connection</b>		<b>ø 50 mm</b>	<b>PRICE</b> € 440,00
		<b>60 - 50</b>	Accessory vacuum inlet connection for ø 50 hoses		
		<b>TEVO5001</b>	Flex Hose Eva 10 meters		
		<b>DCCR50XX</b>	Steel chromed handgrip ø 50		
		<b>SPXO420D</b>	Dust stainless steel floor brush Width 420 mm		
	<b>PM50PA</b>	Accessory vacuum inlet connection			
	<b>CODE</b> KIT5M.50	<b>Kit for general cleaning on models which can fit the 60-50 intel connection</b>		<b>ø 50 mm</b>	<b>PRICE</b> € 370,00
		<b>60 - 50</b>	Accessory vacuum inlet connection for ø 50 hoses		
		<b>TEVO505C</b>	Flex Hose Eva 5 meters		
		<b>DCCR50XX</b>	Steel chromed handgrip ø 50		
		<b>SPXO420D</b>	Dust stainless steel floor brush Width 420 mm		
	<b>PM50PA</b>	Accessory vacuum inlet connection			
	<b>CODE</b> KIT3M.50	<b>Kit for general cleaning on models which can fit the 60-50 intel connection</b>		<b>ø 50 mm</b>	<b>PRICE</b> € 330,00
		<b>60 - 50</b>	Accessory vacuum inlet connection for ø 50 hoses		
		<b>TEVO5001</b>	Flex Hose Eva 3 meters		
		<b>DCCR50XX</b>	Steel chromed handgrip ø 50		
		<b>SPXO420D</b>	Dust stainless steel floor brush Width 420 mm		
	<b>PM50PA</b>	Accessory vacuum inlet connection			
	<b>CODE</b> KIT5M.38	<b>Accessories for general cleaning on models which can fit the 60-50 intel connection</b>		<b>ø 38 mm</b>	<b>PRICE</b> € 165,00
		<b>60 - 38PP</b>	Accessory vacuum inlet connection for ø 38 hoses		
		<b>TEVO385C</b>	Flex Hose Eva 5 meters ø 38 complete with plastic hose cuffs		
		<b>DCCR38PP</b>	Steel chromed handgrip ø 38		
	<b>SPPX400</b>	Plastic liquids or dust floor brush Width 400 mm			
	<b>CODE</b> K38.D0002 K38.W0001	<b>Kit for models provided with 60-38 PP vacuum intel connection Provided with plastic handgrip with aluminum core</b>		<b>ø 38 mm</b>	<b>PRICE</b> € 125,00
		<b>TEVO383C.1</b>	Flex Hose Eva 3 meters ø 38 complete with plastic hose cuffs		
		<b>DCPL38</b>	Ø 38 Plastic handgrip with aluminum care		
		<b>SPPP400D</b>	Plastic dust floor brush Width 400 mm		
		<b>SPPP400W</b>	Plastic liquids floor brush Width 400 mm		
		<b>LP38PL</b>	Plastic ø 38 crevice nozzle		
		<b>PEP38</b>	Plastic round brush ø 38 mm		
	<b>CODE</b> K38.D0003 K38.W0004	<b>Kit for models provided with 60-38 PP vacuum intel connection With steel handgrip and stainless steel floor brush</b>		<b>ø 38 mm</b>	<b>PRICE</b> € 260,00
		<b>TEVO383C.1</b>	Flex Hose Eva 3 meters ø 38 hose cuffs		
		<b>DCCR38XX</b>	Steel chromed handgrip ø 38		
		<b>SPXO420D</b>	Dust stainless steel floor brush Width 420 mm		
		<b>SPXO420W</b>	Liquids stainless steel floor brush Width 420 mm		
		<b>LP38PL</b>	Plastic ø 38 crevice nozzle		
		<b>PEP38</b>	Plastic round brush ø 38 mm		

# KIT ACCESSORIES

	CODE	Kit for general cleaning for models provided with 60-50 vacuum intel connection	Ø 38 mm	PRICE
	K38.D0003 K38.W0004	<b>60 - 50</b>	Accessory vacuum inlet connection for Ø 50 hoses	€ 305,00
	<b>TEVO383C.2</b>	Flex Hose Eva 3 meters with Ø 38 hose cuffs		
	<b>DCCR38XX</b>	Steel chromed handgrip Ø 38		
	<b>SPXO420D</b>	Dust stainless steel floor brush Width 420 mm		
	<b>SPXO420W</b>	Liquids stainless steel floor brush Width 420 mm		
	<b>LP38PL</b>	Plastic Ø 38 crevice nozzle		
	<b>PEP38</b>	Plastic round brush Ø 38 mm		
	CODE	Kit for fine and dry dust suction and ATEX models Available on models which can fit the 60-50 intel connection	Ø 38 mm	PRICE
	K38.DC006	<b>60 - 50</b>	Accessory vacuum inlet connection for Ø 50 hoses	€ 430,00
	<b>TEVO383C</b>	Flex Hose Conductive Eva 3 meters with Ø 38 hose cuffs		
	<b>DCCR38XX</b>	Steel chromed handgrip Ø 38		
	<b>SPXO420D</b>	Dust stainless steel floor brush Width 420 mm		
	<b>PLG44A</b>	Rubber crevice nozzle Ø 38-50		
	<b>PRB80-NY38</b>	Conduction rubber round brush with zinc-plated Ø 38 reductor		
	<b>PT 38 A</b>	Ø 38 rubber cone with zinc-plated reductor		
	CODE	Kit for fine and dry dust suction and ATEX models Available on models where is possible connect the 60-50 intel connection	Ø 50 mm	PRICE
	K50.DC008	<b>60 - 50</b>	Accessory vacuum inlet connection for Ø 50 hoses	€ 510,00
	<b>TEVC503C</b>	Flex Hose Conductive Eva 3 meters with Ø 38 hose cuffs		
	<b>50-50 EST</b>	Ø 50 Quick fit aluminum accessory connection		
	<b>DCCR50XX</b>	Steel chromed Handgrip Ø 38		
	<b>SPXO420D</b>	Dust stainless steel floor brush Width 420 mm		
	<b>PLG44A</b>	Rubber crevice nozzle Ø 38-50		
	<b>PRB80-NY50</b>	Conductive rubber round brush		
	<b>PT 50 A</b>	Ø 50 rubber cone with zinc-plated reductor		
	CODE	Kit ovens suction Available on models which can fit the 60-50 intel connection	Ø 50 mm	PRICE
	K50.W0010	<b>TACC503C</b>	Steel Hose Ø 50 complete with aluminum connections	€ 515,00
	<b>PRAL2050</b>	Aluminum extension Ø 50 - 2 meters		
	<b>SPXO420F</b>	Ovens stainless steel floor brush Width 420 mm		
	<b>PL50AC</b>	Steel chromed crevice nozzle		
	CODE	Kit for mechanical workshops Available on models which can fit the 60-50 intel connection	Ø 50 mm	PRICE
	K50.W0010	<b>TPUH503C</b>	Anti-abrasive SuperFlex Hose 3 meters Ø 50 complete with aluminum connections	€ 560,00
	<b>DCCR50XX</b>	Steel chromed handgrip Ø 50		
	<b>SPXO420O</b>	Liquids stainless steel floor brush with OIL-proof rubbers Width 420 mm		
	<b>PT 50 A</b>	Ø 50 rubber cone with zinc-plated reductor		
	<b>PC 50 A</b>	Bent nozzle 90° angle		
	<b>PV 120 A</b>	Rubber hand scraping tool Ø 50		

# Index

- ▶ Floor Grinding and Polishing Machines ..... pag. 4
- ▶ Diamond Tools and Diamond Floor Pads ..... pag. 20
- ▶ Trowel Shine ..... pag. 36
- ▶ Klinsystem Floor Grinders ..... pag. 38
- ▶ Speedy 3 Step and 4 Step Polishing System..... pag. 42
- ▶ Polish Concrete System ..... pag. 50
- ▶ Marble Polishing System ..... pag. 63
- ▶ Special tools, Bush Hammer, Grinding Cup and Floor Pads ..... pag. 67
- ▶ Granite Polishing System ..... pag. 68
- ▶ Terrazzo Polishing System..... pag. 70
- ▶ Helix and Hypershine Diamond Floor Pads ..... pag. 72
- ▶ Sand Paper, diamond brushes and accessories ..... pag. 76
- ▶ Levitek 500 and Levitek 450 ..... pag. 78
- ▶ Orbital Machines ..... pag. 86
- ▶ Single Disc Machines ..... pag. 94
- ▶ Professional Vacuum Cleaners ..... pag. 98
- ▶ Industrial Vacuum Cleaners BOOST ..... pag. 102
- ▶ Industrial Vacuum Cleaners ASC ..... pag. 106
- ▶ Industrial Vacuum Cleaners BASE ..... pag. 120
- ▶ Car Wash ..... pag. 128
- ▶ Kit Accessories for Industrial Vacuums ..... pag. 130



INTERNATIONAL DIAMOND CODE

24	36	60	120	220	400	800	1500	3500